

# NEW PRODUCT GUIDE

2025

*Hit* PROMOTIONAL  
PRODUCTS

# TABLE OF CONTENTS

<b>Brands</b>	<b>3 - 36</b>	<b>Amenities</b>	<b>109 - 114</b>
<b>Headwear</b>	<b>37 - 40</b>	<b>Tools, Lights &amp; Keytags</b>	<b>115 - 128</b>
<b>Bags</b>	<b>41 - 65</b>	<b>Hitronics</b>	<b>129 - 157</b>
<b>Drinkware</b>	<b>66 - 77</b>	<b>Desk Accessories</b>	<b>158 - 168</b>
<b>Housewares</b>	<b>78 - 85</b>	<b>Food Gifts</b>	<b>169</b>
<b>Leisure</b>	<b>86 - 101</b>	<b>Gift Sets &amp; Kits</b>	<b>170 - 175</b>
<b>Plush &amp; Novelties</b>	<b>102 - 108</b>		

We offer a large selection of Brands to fit any promotional campaign need.  
Please visit our website for more selections.



BRÜMATE

SEE ENTIRE COLLECTION ON OUR WEBSITE





#50216



#50215

#50216 - 40 OZ. BRÜMATE ERA

#50215 - 30 OZ. BRÜMATE ERA

- Made Of Stainless Steel · Powder Coated Finish
- BevGuard™ Insulation To Keep Beverage Ice-Cold And Carbonated For 24+ Hours
- Screw On Ü-Turn™ Spill-Resistant Lid With ColdKey™ Stainless Steel Straw
- Simply Turn The Mode Indicator To The Appropriate Position For Stress-Free Sipping Mode To Open Straw And Sip, Leakproof Mode To Close Straw, Or Cleaning Mode To Clean
- 100% Leakproof When Locked
- Includes A Rubber Grip That Makes Opening Easy Without Having To Touch The Straw
- Comfort Grip Handle · Cup Holder Friendly
- Meets FDA Requirements · BPA Free
- Hand Wash Recommended

#50238 - 35 OZ. BRÜMATE RESA

#50239 - 25 OZ. BRÜMATE RESA

- Made Of Stainless Steel
- Powder Coated Finish
- BevGuard™ Insulation For Keeping Your Drink Cold For Hours
- Screw On Ü-Turn™ Spill-Resistant Lid With ColdKey™ Stainless Steel Straw And Easy Carry Handle
- 100% Leakproof When Locked
- Simply Turn The Mode Indicator To The Appropriate Position For Stress-Free Sipping Mode To Open Straw And Sip, Leakproof Mode To Close Straw, Or Cleaning Mode To Clean
- Features A Rubber Grip That Makes Opening Easy Without Having To Touch The Straw
- Durable And Removable Silicone Body Sleeve Protects Against Drops, Dents And Dings
- Non-Slip Base
- Cup Holder Friendly
- No Condensation
- No Metallic Taste
- Meets FDA Requirements
- BPA Free
- Hand Wash Recommended



#50238



#50239



#50235



#50234  
Optional Second Side Shown

- #50235 - 35 OZ. BRÜMATE NAV
- #50234 - 25 OZ. BRÜMATE NAV
- Made Of Stainless Steel With Silicone Sleeve
- Powder Coated Finish On Stainless Steel Material
- BevGuard™ Insulation For Keeping Your Drink Cold For 24+ Hours And Hot For 6+ Hours
- Screw On, BevLock™ Spill-Resistant Lid With MagFlip™ Technology To Keep Your Lid Open While You Sip
- 100% Leakproof When Locked
- Easy On & Off OctaLock™ Threading System With 8 Different Drinking Positions
- Durable And Removable Silicone Body Sleeve Protects Against Drops, Dents And Dings
- Cup Holder Friendly
- Non-Slip Base
- No Metallic Taste
- Meets FDA Requirements
- BPA Free
- Hand Wash Recommended

#50232 - 25 OZ. BRÜMATE MÜV

- Made Of Stainless Steel
- Powder Coated Finish
- BevGuard™ Insulation For Keeping Your Drink Cold For 24+ Hours And Hot For 6+ Hours
- Screw On, BevLock™ Spill-Resistant Lid With MagFlip™ Technology To Keep Your Lid Open While You Sip
- 100% Leakproof When Locked
- Easy On & Off OctaLock™ Threading System With 8 Different Drinking Positions
- Durable And Removable Color-Matched Silicone Body Sleeve Protects Against Drops, Dents And Dings
- Left And Right Hand Friendly
- Scratch-Resistant And Comfort Grip Handle
- Non-Slip Base
- Cup Holder Friendly
- No Condensation
- No Metallic Taste
- Meets FDA Requirements
- BPA Free
- Hand Wash Recommended

#50233 - 15 OZ. BRÜMATE MÜV

- Made Of Stainless Steel
- Powder Coated Finish
- BevGuard™ Insulation For Keeping Your Drink Cold For 24+ Hours And Hot For 4+ Hours
- Screw On, BevLock™ Spill-Resistant Lid With MagFlip™ Technology To Keep Your Lid Open While You Sip
- 100% Leakproof When Locked
- Easy On & Off OctaLock™ Threading System With 8 Different Drinking Positions
- Durable And Removable Color-Matched Silicone Body Sleeve Protects Against Drops, Dents And Dings
- Left And Right Hand Friendly
- Scratch-Resistant And Comfort Grip Handle
- Non-Slip Base
- Cup Holder Friendly
- No Condensation
- No Metallic Taste
- Meets FDA Requirements
- BPA Free
- Hand Wash Recommended



#50232

#50233



#50214



#50213



#50212

#50214 - 65 OZ. BRÜMATE ROTERA

#50213 - 35 OZ. BRÜMATE ROTERA

#50212 - 25 OZ. BRÜMATE ROTERA

- Made Of Stainless Steel With Silicone Sleeve
- Powder Coated Finish On Stainless Steel Material
- BevGuard™ Insulation To Keep Beverage Ice Cold For 24+ Hours
- Screw On, Spill-Resistant TwistSip™ Lid With ColdKey™ Stainless Steel Straw That Offers On-Demand Sanitary Sips
- Twist Lid To Sip From Straw · Easy Carry Handle On Lid
- Durable And Swappable Silicone Body Sleeve Protects Against Drops, Dents And Dings
- 100% Leakproof When Locked · No Metallic Taste
- Meets FDA Requirements
- BPA Free · Hand Wash Recommended

#35126 - 55 QT. BRÜMATE BRÜTANK ROLLING COOLER

- Made Of Rotomolded Polyethylene
- 7+ Day Ice Retention
- 100% Leakproof
- Made For Enhancing Your Adventures
- Signature Removable 2.8 Gallon Drink Tank With A Built-In Tap
- Holds 2.8 Gallons Of Your Favorite Drink In The Tank Plus 48 - 12 Oz. Cans Or 12 Wine Bottles
- Features Tap™ Tech
- Puncture-Resistant All-Terrain Wheels That Effortlessly Glide Over Any Surface (Including Sand)
- Includes An EVA Foam-Bench Seat Top And A Built-In Bottle Opener

#35056 - 35 QT. BRÜMATE BRÜTANK ROLLING COOLER

- Made Of Rotomolded Polyethylene · 7+ Day Ice Retention
- 100% Leakproof · Made For Enhancing Your Adventures
- Signature Removable 1.8 Gallon Drink Tank With A Built-In Tap
- Holds 1.8 Gallons Of Your Favorite Drink In The Tank Plus 36 - 12 Oz. Cans Or 9 Wine Bottles
- Collapsible, Telescopic Handle
- Puncture-Resistant All-Terrain Wheels That Effortlessly Glide Over Any Surface (Including Sand)
- Includes A Foam Seat Top, A Built-In Bottle Opener And More
- Featured As The Best Hard Cooler In Rolling Stone Essentials 2023



#35126



#35056





**#35129 BRÜMATE MAGPACK™ 24-CAN SHOULDER SLING SOFT COOLER**

- Made Of Durable Shell That Protects Against The Elements
- Lightweight, Durable And Easy To Use
- Made For Ultimate Portability
- Ice Retention For 24+ Hours To Keep Drinks Cooler Longer
- IceShield™ Technology Utilizes An Antimicrobial Closed-Cell Insulation To Ensure Your Drinks Stay Colder, Longer While Protecting Against Mildew And Bacteria
- Zipper-Free Innovative Pivot™ Magnetic Lid To Seal In The Cold And Prevent Leaks
- Holds 24 - 12 Oz. Cans Plus Ice, 21 Lbs Ice Only Or 7 Bottles Of Wine/Liquor Plus Ice
- Cooler Weighs 7.74 Lbs When Empty
- Detachable/Adjustable Shoulder Strap And Padded Web Carrying Handles On Both Sides
- Top Zip Pocket On Lid
- Back Slip Pocket
- Spot Clean/Air Dry
- Sold As Shown



**#35128 BRÜMATE MAGPACK™ 18-CAN SHOULDER SLING SOFT COOLER**

- Made Of Durable Shell That Protects Against The Elements
- Lightweight, Durable And Easy To Use
- Made For Ultimate Portability
- Ice Retention For 24+ Hours To Keep Drinks Cooler Longer
- IceShield™ Technology Utilizes An Antimicrobial Closed-Cell Insulation To Ensure Your Drinks Stay Colder, Longer While Protecting Against Mildew And Bacteria
- Zipper-Free Innovative Pivot™ Magnetic Lid To Seal In The Cold And Prevent Leaks
- Holds 18 - 12 Oz. Cans Plus Ice, 14 Lbs Of Ice Only Or 3 Bottles Of Wine/Liquor Plus Ice
- Cooler Weighs 6.3 Lbs When Empty
- Detachable/Adjustable Shoulder Strap And Padded Web Carrying Handles On Both Sides
- Top Zip Pocket On Lid
- Back Slip Pocket
- Spot Clean/Air Dry
- Sold As Shown



**#35127 BRÜMATE MAGPACK™ 12-CAN SHOULDER SLING SOFT COOLER**

- Made Of Durable Shell That Protects Against The Elements
- Lightweight, Durable And Easy To Use
- Made For Ultimate Portability
- Ice Retention For 24+ Hours To Keep Drinks Cooler Longer
- IceShield™ Technology Utilizes An Antimicrobial Closed-Cell Insulation To Ensure Your Drinks Stay Colder, Longer While Protecting Against Mildew And Bacteria
- Zipper-Free Innovative Pivot™ Magnetic Lid To Seal In The Cold And Prevent Leaks
- Holds 12 - 12 Oz. Cans Plus Ice, 8 Lbs Of Ice Only Or 2 Bottle Wine/Liquor Plus Ice
- Cooler Weighs 6 Lbs When Empty
- Detachable/Adjustable Shoulder Strap And Padded Web Carrying Handles On Both Sides
- Top Zip Pocket On Lid
- Back Slip Pocket
- Spot Clean/Air Dry
- Sold As Shown



# renew

**Introducing Renew, a new initiative furthering our commitment to reducing our impact and providing better choices to the industry. This initiative transitions our best-selling items to materials less harmful to the environment, along with exciting new product launches. Renew offers products you and your clients can feel good about.**



Made with  
**Recycled**  
Materials



**BIODEBASED  
COMPONENTS**



The mark of  
responsible forestry  
FSC® C195385



**UPCYCLE**



# AWS



The AWS collection is in memory of Bill Schmidt Sr., Founder of Hit Promotional Products. Mr. Schmidt was respected and loved by all who had the pleasure to know him. A generous and kind-hearted man, Bill Sr. valued others and had a passion for philanthropy.



To honor his legacy, we will donate 5% of the proceeds from the AWS line that carries his initials. The recipients of those gifts are some of his favorite charities below.



- #25214 AWS RETRO BOOM FM RADIO & WIRELESS SPEAKER
- Wireless Speaker Features High Definition Bluetooth® 5.0 Technology
  - Simply Pair With Your Device To Enjoy Dynamic Stereo Sound
  - Push Buttons To Turn On/Off And To Choose Mode Setting To Switch To Bluetooth®, FM, Aux In, TF Or USB Disc And Turn Knobs For Vol-/Vol+
  - Features FM Radio (87.5 MHz-108.0 MHz)
  - For TransFlash Card Play, Plug TransFlash Card Into TransFlash Slot
  - For USB Play, Plug USB Disc Into USB Port
  - For Aux Mode, Use 3.5mm Plug Audio Cable (Not Included) Into Aux Port To Connect The Speaker And Your Phone · Features Handle For Easy Carry
  - LED Indicator Lights · Battery Capacity: 3.7V/400 mAh · Output: 5W
  - Features A Type-C Input (Cord Included) · Pairs From Up To 33 Feet Away
  - Charge Time Of 2.5 Hours To Full Charge
  - Plays Up To 1 Hour With Max Volume On Full Charge
  - Perfect For Your Home, Office Or Outdoor Activities
  - The Bluetooth® word mark and logos are registered trademarks owned by the Bluetooth SIG, Inc. and any use of such marks by Hit Promotional Products, Inc. is under license. Other trademarks and trade names are those of their respective owners.



#11106 AWS CAMERON CABLE KNIT POM BEANIE  
 · 100% Acrylic  
 · One Size Fits Most

#30113 AWS BUCHANAN PACKABLE TOTE BAG  
 · Made Of 290T Nylon · 210D Polyester Lining  
 · Zippered Main Compartment  
 · Trolley Sleeve On Tote To Fit Over Your Luggage  
 · Includes Pouch · Stows Into Pouch For Travel  
 · Leatherette Accents · Spot Clean/Air Dry  
 · Imprint On Pouch Only



#96007 FLAME WIRELESS SPEAKER LANTERN SET  
 · Set Includes 2 #25237 Flame Wireless Speaker Lanterns  
 · Price Includes 1-Color/1-Location Imprint On Each Speaker



# stasher

LIFE WITH LESS PLASTIC.

Stasher® helps you live life with less plastic with its innovative, beautifully designed, and easy-to-use reusable products. Made with platinum silicone and a leak-free Pinch-Loc® seal, they save the cost of 260 single-use plastic bags a year. Switching to Stasher® is a small win worth celebrating.



#21501



#21502

#### #21501 STASHER® SNACK BAG

- Made From Endlessly Reuseable Silicone
- The Simple, Reusable Alternative To Plastic Bags
- Includes Stasher® Insert Card
- Resealable · Great For Snacks To-Go
- Ideal For Lunch Boxes · Use To Organize Bags & Backpacks
- Label With Any Non-Toxic Dry Erase Or Chalk Marker
- Keep Your Phone Dry If You're Commuting In The Rain Or Sailing Into The Sunset. The Touchscreen Works Through The Bag!
- Low-Waste · TSA-Friendly · Editor's Pick Food Network 2024
- Meets FDA Requirements · Hand Wash Recommended

#### #21502 STASHER® SANDWICH BAG

- Made From Endlessly Reuseable Silicone
- The Simple, Reusable Alternative To Plastic Bags
- add: Includes Stasher® Insert Card
- Resealable · Great For Meal Prepping Or Lunch To-Go
- Replaces Sandwich-Size Plastic Bags
- Use To Organize Bags & Backpacks
- Label With Any Non-Toxic Dry Erase Or Chalk Marker
- Low-Waste · TSA-Friendly · Editor's Pick Food Network 2024
- Meets FDA Requirements · Hand Wash Recommended

#### #95231 STASHER® SNACK KIT

- Kit Includes #21501 Stasher® Snack Bag, Stasher® Insert Card And Your Choice Of Filler
- Pricing Includes 1 Color/1 Location Imprint On #21501 Stasher® Snack Bag. Insert Card Sold As Shown.
- Snack Filler Packaging Will Not Be Imprinted
- Please See Website For Fill Options

#### #95232 STASHER® SANDWICH KIT

- Kit Includes #21502 Stasher® Sandwich Bag, Stasher® Insert Card And Your Choice Of Filler
- Pricing Includes 1 Color/1 Location Imprint On #21502 Stasher® Sandwich Bag. Insert Card Sold As Shown.
- Snack Filler Packaging Will Not Be Imprinted
- Please See Website For Fill Options

# STEEL THE PARTY™ WITH

# STEEL CHILL-CUPS™

#50406 - 16 OZ. STEEL CHILL-CUPS™

- Made Of Infinitely Recyclable Steel · Sturdy, Reusable And Recyclable
- Signature "Chill" Feel Delivers A Great New Frosty Drinking Experience
- 16 Oz. Capacity Is Just The Right Size For Any Chilled Drink
- Can Be Stacked Together For Easy Storage
- When The Party's Over, Simply Recycle Them · Designed To Be Shatter-Proof
- Perfect For Large Celebrations, Corporate Events, Bachelorette Or Bachelor Parties, Or Just A Casual Poolside Drink
- Sturdy Design Lets You Use Them More Than Once Making It A Better Value While Reducing Environmental Impact · Unlike Plastic Party Cups That End Up In Landfills, These Are 100% Recyclable And Can Be Recycled Forever Without Losing Integrity
- Enjoy Cold Drinks In These Sturdy Cups Without Guilt, Or Reuse Them For Your Next Corporate Event
- Meets FDA Requirements · BPA Free · Hand Wash Recommended · Made In USA
- Check Your Local Recycling Abilities Before Adding To Your Recycle Bin



Great chill-to-the-touch feel



Infinitely recyclable  
(75% of all steel is still in use today)



Durable design lets you use more than once



Magnetic steel makes it easier to capture in recycling stream



Silk-Screen



Optional Laser Engraved



Optional Colorbrite Drinkware



# THE *Skyway*<sup>®</sup> LUGGAGE CO.

For over 100 years, the Skyway Luggage Co.<sup>®</sup> has understood your love for travel. That's why their diverse offering of luggage and travel accessories focuses on quality materials, innovative features, and creative designs - to feed your sense of wanderlust again and again.

READY TO  
TAKE YOU  
ANYWHERE.



#34001



#34002



#34001

#### #34002 SKYWAY<sup>®</sup> EPIC 2.0 HARDSIDE LARGE CHECK-IN SPINNER

- Exterior Made Of Strong ABS Polymer
- Functionality And Affordability Combined To Make Your Journey As Effortless As Possible
- Designed For Extended Trips Lasting 5 Days Or Longer
- Telescoping Handle With Comfortable Grip
- Smooth-Rolling Any-Direction Spinner Wheel System
- Top And Side Carry Handles · Foot Studs Protect Luggage When Laid On Side
- Nests With Other Sizes From Collection
- Dual Zippered Main Compartment
- Spacious Main Packing Compartment
- Adjustable Compression Straps
- Secondary Packing Compartment With Zip-Closed Divider
- Roomy Zip Pocket On Divider · Spot Clean/Air Dry

#### #34001 SKYWAY<sup>®</sup> EPIC 2.0 HARDSIDE CARRY-ON SPINNER

- Exterior Made Of Strong ABS Polymer
- Functionality And Affordability Combined To Make Your Journey As Effortless As Possible
- Telescoping Handle With Comfortable Grip
- Smooth-Rolling, Any-Direction Spinner Wheel System
- Top And Side Carry Handles
- Foot Studs Protect Luggage When Laid On Side
- Nests With Other Sizes From Collection
- Dual Zippered Main Compartment
- Spacious Main Packing Compartment
- Adjustable Compression Straps
- Secondary Packing Compartment With Zip-Closed Divider
- Roomy Zip Pocket On Divider · Spot Clean/Air Dry



#35141



#35142



**#35141 SKYWAY® RAINIER SIMPLE BACKPACK**

- Made From Post Consumer Recycled Materials
- Recycled Polyester (rPET) Is Obtained By Melting Down Existing Plastic Bottles And Other Material Sources To Create New Polyester Fiber
- Interior Lining, Zippers And Handles Are Not rPET
- Double Zippered Main Compartment · 2 Zippered Front Pockets
- Adjustable Stowable, Contoured/Padded Shoulder Straps And Web Carrying Handle
- Padded Laptop Pocket · Accommodates Most Laptops Up To 15 1/2"
- Back Trolley Strap · Spot Clean/Air Dry

**#35142 SKYWAY® RAINIER DELUXE BACKPACK**

- Made From Post Consumer Recycled Materials
- Recycled Polyester (rPET) Is Obtained By Melting Down Existing Plastic Bottles And Other Material Sources To Create New Polyester Fiber
- Interior Lining, Zippers And Handles Are Not rPET
- Double Zippered Main Compartment
- Adjustable Stowable, Contoured/Padded Shoulder Straps
- Side Water Bottle Pocket · Magnetic Closure Phone Pocket
- Dual Padded Carry Handles · Side Web Carry Handle
- Zippered Front Pocket With Key Leash And Card Holder
- Zippered Side Pocket
- Side Access Padded Laptop Compartment That Can Be Accessed While Wearing One Strap
- Accommodates Most Laptops Up To 15 1/2" · Interior Padded Divider
- 2 Storage Pockets For Cords · Interior Mesh Pocket
- Back Trolley Strap · Spot Clean/Air Dry

**#34004 SKYWAY® EPIC SOFTSIDE LARGE CHECK-IN SPINNER**

- Exterior Made Of Abrasion-Resistant And Weather-Resistant Twill Polyester
- Functionality And Affordability Combined To Make Your Journey As Effortless As Possible · Telescoping Handle With Comfortable Grip
- Multi-Directional Wheel System · Top And Side Carry Handles
- 2 Easy-Access Front Zippered Pockets · Lockable Zippers (Lock Not Included)
- Dual Zippered Main Compartment · Spacious Main Packing Compartment
- Adjustable Compression Straps · Roomy Zip Pocket On Divider
- Spot Clean/Air Dry

**#34003 SKYWAY® EPIC SOFTSIDE CARRY-ON SPINNER**

- Exterior Made Of Abrasion-Resistant And Weather-Resistant Twill Polyester
- Functionality And Affordability Combined To Make Your Journey As Effortless As Possible · Telescoping Handle With Comfortable Grip
- Multi-Directional Wheel System · Top And Side Carry Handles
- 2 Easy-Access Front Zippered Pockets
- Lockable Zippers (Lock Not Included)
- Dual Zippered Main Compartment · Spacious Main Packing Compartment
- Adjustable Compression Straps · Zippered Pocket Lid · Spot Clean/Air Dry



#34004



#34003



#34008

#34007

**#34008 RICARDO® MALIBU BAY 3.0 SOFTSIDE MEDIUM CHECK-IN EXPANDABLE SPINNER**

- Exterior Made Of Heathered Polyester · Weather-Resistant And Abrasion-Resistant Coating
- Polygiene® Antibacterial Treatment On Touchpoints
- Lightweight Design For Medium-Length Trips And Anyone Who Prefers Packing More And Checking In Their Luggage · Telescoping Handle With Comfortable Grip
- Dual, Smooth-Rolling 360° Spinner Wheel System Recessed For Stability
- Dual Zippered Front Pocket · Expandable · Faux-Leather Accents
- Cases Nest Together For Easy Storage · Dual Zippered Main Compartment
- Spacious Main Packing Compartment · Includes A Large Packing Cube For Organization
- Side Zip Pocket · Adjustable Compression Straps · Secondary Packing Compartment
- Zip Pockets On Lid Compartment · Wet Pocket · YKK-EYL Lockable Zippers (Lock Not Included)
- Spot Clean/Air Dry

**#34007 RICARDO® MALIBU BAY 3.0 SOFTSIDE CARRY-ON EXPANDABLE SPINNER**

- Exterior Made Of Heathered Polyester
- Weather-Resistant And Abrasion-Resistant Coating
- Polygiene® Antibacterial Treatment On Touchpoints · Lightweight
- Designed To Fit The Sizer Of Major US Airlines With A Little Extra Room For Packing More
- Telescoping Handle With Comfortable Grip
- Dual, Smooth-Rolling Any-Direction Spinner Wheel System Recessed For Stability
- Integrated USB Port For Tech Charging · Internally Routed Cord To USB Port
- Pouch For Removable Battery · Dual Zippered Front Pocket · Expandable
- Faux-Leather Accents · Cases Nest Together For Easy Storage
- Dual Zippered Main Compartment · Spacious Main Packing Compartment
- Includes Removable TSA-Friendly Pouch And Large Packing Cube For Organization
- Side Zip Pocket · Adjustable Compression Straps · Secondary Packing Compartment
- Zip Pockets On Lid Compartment · Wet Pocket
- YKK-EYL Lockable Zippers (Lock Not Included) · Spot Clean/Air Dry



#34006 RICARDO® MALIBU BAY 3.0 SOFTSIDE WEEKENDER CARRY-ON DUFFEL

- Exterior Made Of Abrasion-Resistant And Weather-Resistant Heathered Polyester
- Versatile, Quick And Easy Design For A Short Getaway Or On The Go
- Generous Packing Capacity
- Adjustable/Detachable Shoulder Strap And Dual Reinforced Handles
- Double Zippered Main Compartment · Front Slip Pocket
- Handle Pass-Through Sleeve Doubles As An Extra Pocket For Transporting On Top Of A Suitcase
- Faux-Leather Trim · Quilted Laptop Pocket
- Padded Tablet Pocket
- 2 Stash Pouches · Interior Zip Pocket
- YKK-EYL Zippers · Spot Clean/Air Dry



#34005 RICARDO® MALIBU BAY 3.0 SOFTSIDE CONVERTIBLE TECH BACKPACK

- Exterior Made Of Abrasion-Resistant And Weather-Resistant Heathered Polyester
- Designed For Everyday Use · Casual Carry-On Backpack Performs Well Under Any Conditions
- Adjustable Stowable, Padded Back Straps With Sport Mesh Ventilation
- Accommodates Most Laptops Up To 15" · Dual Hideaway Carry Handles
- 3 Front Pockets With Organizer Flat Pouches And Key Leash
- Double Zippered Main Compartment · 2 Zippered Side Pockets
- Handle Pass-Through Sleeve Doubles As An Extra Pocket For Transporting On Top Of A Suitcase
- Faux-Leather Trim And Touchpoints
- Metal Hardware · Quilted Laptop Pocket
- Padded Tablet Pocket · Magnetic Pocket And 2 Stash Card Pockets For Pens And Business Cards
- YKK-EYL Zippers · Spot Clean/Air Dry



#35137 RICARDO® AVALON SOFTSIDE 16" SMALL CARRY-ON

- Made From Post Consumer Recycled Materials
- Recycled Polyester (rPET) Is Obtained By Melting Down Existing Plastic Bottles And Other Material Sources To Create New Polyester Fiber
- Zippers, Zipper Pulls, Wheels And Handles Are Not rPET
- Perfect For Short Trips
- Fits Neatly Under Most Airline Seats, Ensuring A Hassle-Free Travel Experience
- Double Zippered Main Compartment
- Large Packing Capacity
- Front Zippered Pocket
- In-Line Skate Wheels
- Quick Access Large Front Pocket
- Large Top Opening
- Back Trolley Strap
- Side Zippered Pocket
- Telescoping Handle
- Top Padded Carrying Handle
- Reinforced Corner Protectors
- Interior Zippered Pockets
- Includes Removable Zippered 3-1-1 Wet Pouch
- Spot Clean/Air Dry



#35140 RICARDO® AVALON SOFTSIDE 28" EXPANDABLE CHECK-IN

- Made From Post Consumer Recycled Materials
- Recycled Polyester (rPET) Is Obtained By Melting Down Existing Plastic Bottles And Other Material Sources To Create New Polyester Fiber
- Zippers, Zipper Pulls, Wheels And Handles Are Not rPET
- Quiet 360° Any-Direction Dual Wheels
- Telescoping Handle With Comfortable Grip
- Double Zippered Main Compartment
- Expandable Packing Capacity
- Dual Zippered Front Pocket
- Quick Access Zippered Front Pocket
- Top And Side Padded Carry Handles
- Bottom Carry Handle
- TSA-Recognized Combination Lock
- Generous Packing Compartment
- Adjustable Compression Straps
- 2 Large Zip-Mesh Interior Pockets
- 1 Large Zippered Interior Wet Pocket On Lid Opening Side Of Case
- Spot Clean/Air Dry





#35139 RICARDO® AVALON SOFTSIDE 24" EXPANDABLE CHECK-IN

- Made From Post Consumer Recycled Materials
- Recycled Polyester (rPET) Is Obtained By Melting Down Existing Plastic Bottles And Other Material Sources To Create New Polyester Fiber
- Zippers, Zipper Pulls, Wheels And Handles Are Not rPET
- Quiet 360° Any-Direction Dual Wheels
- Telescoping Handle With Comfortable Grip
- Double Zippered Main Compartment · Expandable Packing Capacity
- Dual Zippered Front Pocket · Quick Access Zippered Front Pocket
- Top And Side Padded Carry Handles · Bottom Carry Handle
- TSA-Recognized Combination Lock · Expandable Packing Capacity
- Generous Packing Compartment · Adjustable Compression Straps
- 2 Large Zip-Mesh Interior Pockets
- 1 Large Zippered Interior Wet Pocket On Lid Opening Side Of Case
- Spot Clean/Air Dry



#35138 RICARDO® AVALON SOFTSIDE 20" EXPANDABLE CARRY-ON

- Made From Post Consumer Recycled Materials
- Recycled Polyester (rPET) Is Obtained By Melting Down Existing Plastic Bottles And Other Material Sources To Create New Polyester Fiber
- Zippers, Zipper Pulls, Wheels And Handles Are Not rPET
- Quiet 360° Any-Direction Dual Wheels
- Telescoping Handle With Comfortable Grip
- Double Zippered Main Compartment · Expandable Packing Capacity
- Top Zippered Pocket · Dual Zippered Front Pocket
- Quick Access Zippered Front Pocket
- Top And Side Padded Carry Handles · Bottom Carry Handle
- TSA-Recognized Combination Lock · Generous Packing Compartment
- Adjustable Compression Straps · 2 Large Zip-Mesh Interior Pockets
- 1 Large Zippered Interior Wet Pocket On Lid Opening Side Of Case
- Includes 3-1-1 TSA Recognized Zippered Toiletry Bag · Spot Clean/Air Dry





- #34009 TUMI SPORT ESSENTIAL NORTH/SOUTH TOTE
- Made Of Ballistic Nylon · Snap Closure For Main Compartment
  - Front Zippered Pocket · Leather Top Carry Handles
  - 2 Open Interior Pockets (1 Waterproof)
  - Interior Zippered Pocket · Interior Key Leash · Daisy Chains
  - Quickly And Easily Add Another Travel Piece With The Add-A-Bag Strap
  - TUMI Tracer® · Spot Clean/Air Dry



- #34010 TUMI SPORT ESSENTIAL MEDIUM EAST/WEST TOTE
- Made Of Ballistic Nylon · Snap Closure For Main Compartment
  - Front Zippered Pocket · Leather Top Carry Handles
  - 2 Open Interior Pockets (1 Waterproof) · Interior Zippered Pocket
  - Interior Key Leash · Daisy Chains
  - Quickly And Easily Add Another Travel Piece With The Add-A-Bag Strap
  - TUMI Tracer® · Spot Clean/Air Dry



#34010  
Accessories Not Included



#### #34011 TUMI SPORT GOLF STAND BAG

- Made Of Ballistic Nylon
- 2 Angled, Gusseted, Exterior Zippered Pockets
- Open Side Pocket With Magnetic Closure
- Temperature Insulated Cooler
- Vertical Side Zippered Pocket
- Front U-Zip Pocket
- U-Zip Pocket With Protective Lining And Lockable Kissing Slider
- 2 Interior Zippered Mesh Pockets
- Webbing Strap At Rear For Keeping Stand Legs Secure When Not In Use
- Articulating, Molded Bottom Component Bends To Adjust With Standing Or In-Play Functionality
- Stand Legs Extend And Retract To Allow For Angled, Easy Access To Clubs While In Play/Stowage When In Transit Or Stored
- Webbing And Elastic Loops With Hook For Attaching Golf Umbrella
- Quilted Mesh Side Panels For Added Comfort When Carrying
- Padded, Adjustable And Removable Articulating Backpack Straps With Leather Accents
- Front Webbing Carry Handles With Leather Grips
- Zip Hood Snaps Onto Bag
- Multi-Function Carabiner With Integrated Bottle Opener
- Includes TUMI Towel And Luggage Tag
- Webbing Daisy Chains
- Features A USB-C Port
- 5 Dividers For Golf Clubs
- Mesh Covered Top Component With Overmold Carry Handle
- TUMI Tracer®
- Spot Clean/Air Dry



#### #34012 TUMI SPORT 3 PACK GOLF CLUB COVER SET

- Made Of Ballistic Nylon
- Includes One Driver Golf Club Cover, One Fairway Golf Club Cover And One Hybrid Golf Club Cover
- Soft-Touch, Padded Lining To Protect Club Heads
- Hidden Magnetic Closure
- Premium Gift Box Included
- Spot Clean/Air Dry



Optional Stainless Steel Plate Shown



**#30114 BRANDCHARGER® BUMBLE ECO FANNY PACK**

- Made From Post Consumer Recycled Materials
- Recycled Polyester (rPET) is Obtained By Melting Down Existing Plastic Bottles And Other Material Sources To Create New Polyester Fiber
- Lining, Zipper, Strap And Buckle Are Not rPET
- Perfect For Daily Essentials
- Can Be Worn As A Fanny Pack Or As A Chest Sling
- Zippered Main Compartment
- Interior Zip Pocket · Adjustable Waist Strap · Spot Clean/Air Dry

**#25222 BRANDCHARGER® PHONE WRISTBAND**

- Made Of Polyester
- Convert Any Phone Instantly Into A Hands-Free Wrist Strap Carry Case
- Adjustable 8MM Rope Wrist Loop With Lobster Claw Attachment And Tether Patch
- Lightweight And Durable
- Tether Patch Fits Inside Phone Case And Attaches To Wristband
- Allows Access To Charging Port
- Fits Most Smartphones



**#35076 BRANDCHARGER® ECO SLING BACKPACK**

- Made From Post Consumer Recycled Materials
- Recycled Polyester (rPET) is Obtained By Melting Down Existing Plastic Bottles And Other Material Sources To Create New Polyester Fiber
- Lining, Zipper And Strap Are Not rPET · Ergonomic Cross-Body Silhouette
- Expandable Pocket For Phone Or Water Bottle · Reflective Elements For Road Safety
- Folds Into Itself For Compact, Easy Travel · Anti-Theft Covered Zipper
- Breathable Mesh Strap · Spot Clean/Air Dry



Phone And Case Not Included

# RECESS PICKLEBALL

**WOMEN  
OWNED**

## Pickleball Essentials That Pair Quality With Design For Players Of All Levels



Includes Canvas Cover  
Comes As Shown



### #40005 RECESS PICKLEBALL PADDLE

- Interior Core Made Of Sturdy 1/2" Honeycomb Polypropylene
- Edge Guard Is Made Of Custom Thermoplastic Polyurethane (TPU) Designed To Withstand The Elements
- Surface Is Made Of Durable Fiberglass With A Sanded Texture For Extra Spin
- 4 1/4" Grip Circumference
- Custom Grip Band Ring To Hold The Grip Tape In Place
- Grip Is Made Of Highly Condensed EVA Foam Covered With Sweat-Proof Saddle Brown Leather Color Grip Tape
- Includes A Canvas Zippered Paddle Cover With Leather Detailing
- Cover Keeps Paddle Safe And Clean When Not In Use
- Canvas Cover Comes As Shown
- Perfect For An Impromptu Pickleball Game With Friends Or A Spontaneous Day In The Sun!
- Women Owned

# ROASTIFY

Choose From Our Expertly Crafted Blends And Elevate Your Brand With Coffee That Not Only Tastes Exceptional But Also Tells Your Story. Enhance Your Coffee's Presentation And Make A Lasting Impression On Your Customers With Tailor-Made Bags

## FRENCH ROAST COFFEE

- This Roast Has A Robust Flavor Profile That Generally Carries Notes Of Chocolate, Caramel, Or Even Smokiness, And May Have A Slightly Bitter Aftertaste
- Tasting Notes Of Cocoa, Toasted Nuts And A Strong Finish
- Perfect For Someone Looking For Something A Little More Classic And Traditional · Great With Cream And Sugar, Or Drink It Straight Up
- Performs Well With Drop Coffee Maker, French Press Or Percolator
- Classic, Traditional And Strong, Bold Flavor
- Grow Regions: South & Central America · Made In USA

#99214 - 12 Oz. Roastify Whole Bean French Roast Coffee

#99215 - 12 Oz. Roastify Ground French Roast Coffee

## DECAF COFFEE

- Water-Washed Decaf That Ensures Rich Flavor Profile While Offering A Safe And Chemical Free, Caffeine Removal Process
- With A Medium Roast Profile, This Coffee Offers Subtle Tasting Notes Of Peanut And Milk Chocolate With Mellow Acidity
- Performs Well With Drip Coffee Maker, French Press Or Percolator
- Grow Regions: South America · Made In USA

#99216 - 12 Oz. Roastify Whole Bean Decaf Coffee

#99217 - 12 Oz. Roastify Ground Decaf Coffee



#99212



#99211

## LIGHT ROAST COFFEE

- A Light Roast Results In A Coffee Bean That Is Lighter In Color And Has A Higher Level Of Acidity And A More Delicate Flavor
- Tasting Notes Of Hints Of Milk Chocolate, Dried Fruits And Almonds
- Best Enjoyed As A Pour Over, Aeropress, Espresso Or Cold Brew
- Perfect For The Connoisseur Looking For Something Citrusy And Fruity
- Grow Regions: South & Central America · Made In USA

#99210 - 12 Oz. Roastify Whole Bean Light Roast Coffee

#99211 - 12 Oz. Roastify Ground Light Roast Coffee

## MEDIUM ROAST COFFEE

- Medium Roast Coffees Have A Flavor Profile That Is Less Delicate Than Light Roasts, But Not As Bold As Dark Roasts, And Often Have A Slight Sweetness And Nuttiness
- Tasting Notes Of Sweet Orange, Chocolate And Brown Sugar
- Performs Well With Any Brew Method, Including Drip Coffee Maker, Pour Over, Espresso, Moka Pot Or Cold Brew
- This Is A Crowd Pleaser For Any Occasion Or Any Coffee Drinker
- Grow Regions: South & Central America · Made In USA

#99212 - 12 Oz. Roastify Whole Bean Medium Roast Coffee

#99213 - 12 Oz. Roastify Ground Medium Roast Coffee



# Classique

BY VEF

Classique by VeF offers timeless, signature arrangements of eternity® roses placed in a classic Parisian-inspired hat box. Dehydrated and preserved, eternity® rose arrangements will last up to a year or longer, while still feeling and smelling fresh.



**#93920 CLASSIQUE BY VEF LE MINI™ ROUND**  
 · Choice of Rose Colors: Blush, Lavender, Pink, Red Or White  
 · Arrangements Feature A Stunning, Singular Eternity® Rose,  
 Set In A Luxurious Parisian-Inspired Round Hat Box  
 · Ideal Arrangements For Elevating Any Small Space, And  
 Serve As Perfect Gifts

**#93922 CLASSIQUE BY VEF LE PETIT**  
 · Choice of Rose Colors: Blush, Lavender, Pink, Red Or White  
 · Arrangements Feature 4 Stunning Eternity® Roses Set In A  
 Luxurious Parisian-Inspired Square Hat Box  
 · Ideal Arrangements For Elevating Any Small To Medium Space,  
 And Serve As Perfect Gifts

**#93921 CLASSIQUE BY VEF SMALL ROUND**  
 · Choice of Rose Colors: Blush, Lavender, Pink, Red Or White  
 · Arrangements Are Comprised Of 13-15 Exquisite Eternity®  
 Roses Set In A Parisian-Inspired Hat Box Vase  
 · Elevate Any Space With Grace And Simplicity

**#93923 CLASSIQUE BY VEF LE MINI™ SQUARE**  
 · Choice of Rose Colors: Blush, Lavender, Pink, Red Or White  
 · Arrangements Feature 9 Stunning Mini Eternity® Roses,  
 Set In A Classic Parisian-Inspired Square Hat Box  
 · Ideal Arrangements For Elevating Any Small Space, And Serve  
 As Perfect Gifts



Bloomin Is B Corp Certified. B Corp Certification Is A Designation That A Business Is Voluntarily Meeting High Standards Of Verified Performance, Accountability, And Transparency On Factors From Employee Benefits To Supply Chain Practices And Input Materials. The Standards Are Developed Independently And Cover A Company's Impact In Key Areas, Including Governance, Workers, Community, Environment, And Customers.



#93926 BLOOMIN® SEED PAPER WINE NECKER

- Made Of Recycled Post-Consumer Paper Pulp Made With Non-GMO Seeds
- Filled With Mixture Of Wildflower Seeds
- Seeds Grow Well In All Climates And Regions
- Plant Seed Paper, Water And Enjoy



#93924 BLOOMIN® SEED PAPER NOTEBOOK

- Front And Back Cover Made Of Recycled Post-Consumer Paper Pulp Made With Non-GMO Seeds
- Cover Is Filled With Mixture Of Wildflower Seeds
- Seeds Grow Well In All Climates And Regions
- Unlined 30 Page Journal
- Pages Made Of Text Weight Paper
- Remove Pages Inside, Plant Seed Paper, Water And Enjoy



#93925 BLOOMIN® MINI PLANTING KIT

- Made Of Recycled Post-Consumer Paper Pulp Made With Non-GMO Seeds
- Filled With Mixture Of Wildflower Seeds
- Seeds Grow Well In All Climates And Regions
- Includes Recycled Cardstock Wrap, Medallion Made Of Plantable Seed Paper, Biodegradable Pot And Soil
- Everything You Need To Start Your Own Flower Garden In Your Own Window Sill
- Plant, Water And Enjoy



- #93927 BLOOMIN® SEED PAPER COASTER
- Made Of Recycled Post-Consumer Paper Pulp Made With Non-GMO Seeds
  - Filled With Mixture Of Wildflower Seeds
  - Seeds Grow Well In All Climates And Regions
  - Perfect For One-Time Use
  - Plant Seed Paper, Water And Enjoy



Optional Hemp Ribbon Shown

- #93928 BLOOMIN® SEED PAPER PRODUCT TAG
- Made Of Recycled Post-Consumer Paper Pulp Made With Non-GMO Seeds
  - Filled With Mixture Of Wildflower Seeds
  - Seeds Grow Well In All Climates And Regions
  - Plant Seed Paper, Water And Enjoy



- #93929 BLOOMIN® SEED PAPER CONFETTI GIFT PACK
- Made Of Recycled Cardstock And Post-Consumer Paper Pulp Made With Non-GMO Seeds
  - Filled With Mixture Of Wildflower Seeds
  - Seeds Grow Well In All Climates And Regions
  - Includes Custom-Printed Recycled Info Card And 12 Handmade Plantable Growfetti Shapes
  - Choose From Flowers, Hearts, 1/2" Circles, 1/2" Squares, Hexagons Or Wine Bottles
  - Plant Seed Paper, Water And Enjoy

To stay ahead of the curve, PhoneSuit® delivers the performance and power your mobile devices need.



#29009  
Phone Not Included



#29006  
Phone Not Included

**#29009 - 65W PHONESUIT® WIRELESS ALL-IN-ONE CHARGER WALL ADAPTER & 10,000 MAH BATTERY PACK**

- Made Of Polycarbonate Composite
- Charge Qi Enabled Devices Wirelessly By Placing Device On The Charging Pad
- Output: 7.5W, 15W
- 10,000 mAh Lithium-Ion Polymer Battery Provides Up To 3 Times Extra Phone Charge
- Charge Anytime, At Home Or On The Go! · AC Wall Charger & Wireless Battery Pack
- All-In-One Portable, Ultra-Slim Charger For Travel, Home, Office & More
- Super-Slim Contoured Form-Factor Feels Great In Hand
- Slim, Foldable Wall Charger Design Lets You Charge Your Devices Via Wall Outlet Anywhere You Go
- Pass Through Charging Allows You To Power Up Immediately
- Ultra-Strong Neodymium Magnets Attach To Your Apple® MagSafe® iPhone® Or MagSafe® Compatible Case To Charge Wirelessly
- Works With MagSafe® Cases · Features AC Input And USB-A & USB-C Outputs
- Up to 300% Extra Charge · Features A Type-C Input (Cord Included)
- Compatible With iPhone® 15 Series, iPhone® 14 Series, iPhone® 13 Series, iPhone® 12 Series, AirPods® & More
- Apple, MagSafe, iPhone, and AirPods are trademarks of Apple Inc., registered in the U.S. and other countries.

**#29006 - 10,000 MAH PHONESUIT® MAG MAX WIRELESS PORTABLE POCKET CHARGER & BATTERY PACK**

- Made Of Polycarbonate
- Charge Qi Enabled Devices Wirelessly By Placing Device On The Charging Pad
- Output: 7.5W, 10W
- 10,000 mAh Rechargeable Battery Pack
- 3-In-1: Portable Charger, Charge Pad & Universal Power Bank
- Magnets Attach To Your Apple® MagSafe® iPhone® Automatically To Charge Wirelessly
- Ultra-Strong Neodymium Magnets
- Over 200% Extra Charge
- Super-Slim Contoured Form-Factor Feels Great In Hand
- Form Fitting Battery Pack For iPhone® 15, 14, 13 & 12 Series
- Apple® MagSafe® Compatible
- Works With MagSafe® Cases
- USB-C In/Out Port, USB-A Output Port
- Charge USB Devices By Cable
- Includes Elite Mag Wireless Charger And USB-C Cable
- Apple, MagSafe, and iPhone are trademarks of Apple Inc., registered in the U.S. and other countries.



**#29005 - 5,000 MAH PHONESUIT® MAG MAX WIRELESS PORTABLE POCKET CHARGER & BATTERY PACK**

- Made Of Polycarbonate
- Charge Qi Enabled Devices Wirelessly By Placing Device On The Charging Pad
- Output: 7.5W, 10W
- 5,000 mAh Rechargeable Battery Pack
- 3-In-1: Portable Charger, Charge Pad & Universal Power Bank
- Magnets Attach To Your Apple® MagSafe® iPhone® Automatically To Charge Wirelessly
- Ultra-Strong Neodymium Magnets
- Up To 100% Extra Charge
- Super-Slim Contoured Form-Factor Feels Great In Hand
- Form Fitting Battery Pack For iPhone® 15, 14, 13 & 12 Series
- Works With MagSafe® Cases
- USB-C In/Out Port, USB-A Output Port
- Charge USB Devices By Cable
- Includes Elite Mag Wireless Charger And USB-C Cable
- Apple, MagSafe, and iPhone are trademarks of Apple Inc., registered in the U.S. and other countries.

**#29008 - 65W PHONESUIT® FAST CHARGING WALL CHARGER PRO**

- Made Of Polycarbonate Composite
- Minimal, Ultra-Small And Portable
- Foldable AC Wall Prongs And High-Speed Charging Capabilities
- Features 1 USB-A & 2 USB-C Output Ports
- 65W Power Delivery
- Designed To Charge At Home, Office & Traveling
- GaN Fast-Charge
- Charge Up To 3 Devices Simultaneously
- Features A Type-C Input (Cord Included)
- Compatible With Laptops, iPhone® 15/14/13/12/11/X, iPad®, Samsung Galaxy, Google & More
- Smart Chipset Provides High Quality Power Output And Charging Safety Monitors With Voltage, Short Circuit, Temperature And Current Protection Features
- Apple, MagSafe, iPhone, and AirPods are trademarks of Apple Inc., registered in the U.S. and other countries.
- Apple, iPhone, and iPad are a trademark of Apple Inc., registered in the U.S. and other countries.



Phone & Cords Not Included



**#29001 PHONESUIT® MAG MAX CAR MOUNT & WIRELESS CHARGER**

- Made Of Polycarbonate
- Charge Qi Enabled Devices Wirelessly By Placing Device On The Charging Pad
- Compatible With Apple® iPhone® 15, 14, 13 & 12 Series & More
- Works With MagSafe® Compatible Cases
- Includes Wireless Charging Car Dock, Vent Mount, USB Car Charger (Lighter Input) And USB-C Cable
- Simply Place Your iPhone® On The Car Dock And The Magnets Will Securely Connect To Provide You With Immediate Wireless Power
- Output: 5W, 7.5W, 10W (Max) · USB-C In Port
- Ultra-Strong Neodymium Magnets Holds iPhone® In Place
- No Sticky Glue or Residue · Fits Most Straight Automobile Air Vents
- Apple and MagSafe are trademarks of Apple Inc., registered in the U.S. and other countries.



Phone Not Included

# The SmartNotebook®



- #94079 THE SMARTNOTEBOOK® POCKET SIZE SMART FLEX
- Made Of Paper And Polyurethane · 174 Dotted Pages
  - Paper Made Of Sugar Cane Bagasse · Pocket Sized
  - Connect Your Notebook To Your Tablet Or Smartphone Through A QR Code On Each Sheet And Digitize All The Content Of Your Handwritten Notes In The SmartNotebook® App
  - No Special Pen Needed · Flexible Material Made To Bend
  - Elastic Band For Closure · Scan, Share, Create Alerts, And Edit
  - Handmade · Comes With Case
  - Free App Available For iOS And Android



- #65045 THE SMARTNOTEBOOK® SMART FLEX
- Made Of Paper And Polyurethane · 190 Dotted Pages Plus 4 Pages Of Mandalas
  - Paper Made Of Sugar Cane Bagasse
  - Connect Your Notebook To Your Tablet Or Smartphone Through A QR Code On Each Sheet And Digitize All The Content Of Your Handwritten Notes In The SmartNotebook® App
  - No Special Pen Needed · Flexible Material Made To Bend
  - Elastic Band For Closure · Scan, Share, Create Alerts And Edit
  - Handmade · Comes With Case · Free App Available For iOS And Android



- #94078 THE SMARTNOTEBOOK® SMART FLEX
- Made Of Paper And Polyurethane · 190 Dotted Pages Plus 4 Pages Of Mandalas
  - Paper Made Of Sugar Cane Bagasse
  - Connect Your Notebook To Your Tablet Or Smartphone Through A QR Code On Each Sheet And Digitize All The Content Of Your Handwritten Notes In The SmartNotebook® App
  - No Special Pen Needed · Flexible Material Made To Bend
  - Elastic Band For Closure · Scan, Share, Create Alerts And Edit · Handmade
  - Comes With Case · Free App Available For iOS And Android



- #94077 THE SMARTNOTEBOOK®
- Made Of Paper And Polyurethane
  - 190 Dotted Pages Plus 4 Pages Of Mandalas And 1 Pen Testing Page
  - Paper Made Of Sugar Cane Bagasse · Hardcover Material
  - Connect Your Notebook To Your Tablet Or Smartphone Through A QR Code On Each Sheet And Digitize All The Content Of Your Handwritten Notes In The SmartNotebook® App
  - No Special Pen Needed · Always Have Your Physical Notes · Elastic Band For Closure
  - Scan, Share, Create Alerts And Edit · Handmade · Comes With Case
  - Free App Available For iOS And Android



#94087 POWERSTICK TOP BOUND NOTES KIT

- Kit Includes #94071 Powerstick Acorn Top Bound Notebook, #94083 Powerstick Script And #94084 Powerstick PenPal Clip
- Pricing Includes A 4-Color Imprint On #94071 Powerstick Acorn Top Bound Notebook, #94083 Powerstick Script And #94084 Powerstick PenPal Clip

#94088 POWERSTICK SIDE BOUND NOTES KIT

- Kit Includes #94070 Powerstick Acorn Side Bound Notebook, #94083 Powerstick Script And #94084 Powerstick PenPal Clip
- Pricing Includes A 4-Color Imprint On #94070 Powerstick Acorn Side Bound Notebook, #94083 Powerstick Script And #94084 Powerstick PenPal Clip



#94090 POWERSTICK SIDE BOUND MORE NOTES KIT

- Kit Includes #94072 Powerstick Willow Side Bound Notebook, #94083 Powerstick Script And #94084 Powerstick PenPal Clip
- Pricing Includes A 4 Color Imprint On #94072 Powerstick Willow Side Bound Notebook, #94083 Powerstick Script And #94084 Powerstick PenPal Clip

#94091 POWERSTICK TOP BOUND MORE NOTES KIT

- Kit Includes #94073 Powerstick Willow Top Bound Notebook, #94083 Powerstick Script And #94084 Powerstick PenPal Clip
- Pricing Includes A 4 Color Imprint On #94073 Powerstick Willow Top Bound Notebook, #94083 Powerstick Script And #94084 Powerstick PenPal Clip



Items And Pen Not Included



**#94084 POWERSTICK PENPAL CLIP**

- Fits Most Writing Instruments
- Clips To Any Notebook Or Journal
- Slide The Clip On Your Notebook Cover And The Elastic Strap Will Securely Hold Your Writing Instrument
- Flexible Teeth Allow Slip To Securely Grip On Most Thick Covers
- Can Also Be Used With Tablet Stylus Or Slim Whiteboard Marker
- Can Be Removed And Reused On Different Books



**#94083 POWERSTICK SCRIPT**

- Removable Cap With Clip
- Minimal And Modern Design
- Smooth-Writing
- Dries Quickly Without Smudging
- 0.7MM Black Gel Ink



**#94074 POWERSTICK MAGNASCULPT**

- Interactive Desktop Activity And Art Sculpture
- Features A Magnetic Base, 30 Magnetic Bars And 15 Metal Ball Bearings
- Can Be Endlessly Rearranged To Form Sleek 3D Sculptures And Designs
- Promotes Creativity And Focus
- Not Intended For Children (Includes Small Parts)



**#94089 POWERSTICK MOLECULE DESKTOP SCULPTURE SET**

- Ignite Your Creativity, Stimulate Your Mind And Deck-Out Your Desk
- The Perfect Gift For Creatives, Out Of The Box Thinkers And Anyone With A Curious Mind
- Includes 36 Building Pegs And 15 Connection Spheres
- Features Non-Slip Feet
- Promotes Creativity & Focus
- One-Of-A-Kind Gift Idea





Wallet Not Included

**#94094 POWERSTICK POWERTAG CARD**

- Slim Body Allows It To Easily Be Stored In A Wallet Or Attached To A Keychain (Split Ring Not Included)
- Slim Tracker Is Charged Wirelessly
- Compatible With The Apple® Find My Application For iPhone Users, While Android Users Can Download The Spot 2.0 Bluetooth® Finder App To Pair And Connect To The PowerTag Card
- Features Bluetooth 5.3 And A Range Of 300 Ft.
- Ring To Find Sounds An Alert From Your PowerTag Card
- Location History Will Map The Last Location Your PowerTag Card Was Together With Your Phone
- Mark As Lost If A PowerTag Card Is Lost & Shows Disconnected. The Network Of Users Can Help Find It
- Proximity Meter Is An Indicator Of The Connected Signal Strength Shown By Yellow Rings
- Out Of Range Alerts Will Sound An Alert From Your Phone When PowerTag Card Gets Too Far Apart
- Apple and iPhone are trademarks of Apple Inc., registered in the U.S. and other countries



**#94081 POWERSTICK PRESTO POCKET SPEAKER**

- Bluetooth® 5.1 With Low-Energy Consumption
- 30-Foot Bluetooth® Connectivity Range
- Gray Strap Included In Box
- Passive Radiator For Bass Boost
- Simple On/Off Controls & LED Status Light
- Quickly Recharges Via USB C Cable
- Impressive Sound And Playback Time Up To 8 Hours Of Play Time
- Rubber Feet



Phone Not Included



Phone Not Included

#### #94093 POWERSTICK ACTIVO

- Bluetooth® 5.0 Technology To Pair To Your Phone/Device
- 30-Foot Bluetooth® Connectivity Range
- Great Sound From Passive Radiator And 5-Watt Driver
- Durable Rubberized Exterior · Playback Time Up To 6+ Hours
- Water-Resistant Up To IPX6 · Magnetic Base
- Includes Fabric Tab For Convenient Portability
- Includes USB A To USB C Cable · 600 mAh Lithium Ion Battery

#### #94092 POWERSTICK POWERMAG

- MagSafe® Compatible Wireless Charger That Magnetically Connects To The Back Of Your Phone Or MagSafe® Case
- Output: 10W · 5,000 mAh Lithium Ion Battery Included
- Perfect For On-The-Go Charging
- Includes Adhesive Magnetic Ring To Convert Non-MagSafe® Phones
- Flip-Out Stand Props Your Phone For Hands-Free Viewing
- Can Also Be Used As A Traditional Power Bank With Your Phone's Charging Cable
- LED Lights Indicate Battery Reserve · Includes USB A To USB C Cable
- MagSafe is a trademark of Apple Inc., registered in the U.S. and other countries



Keys Not Included

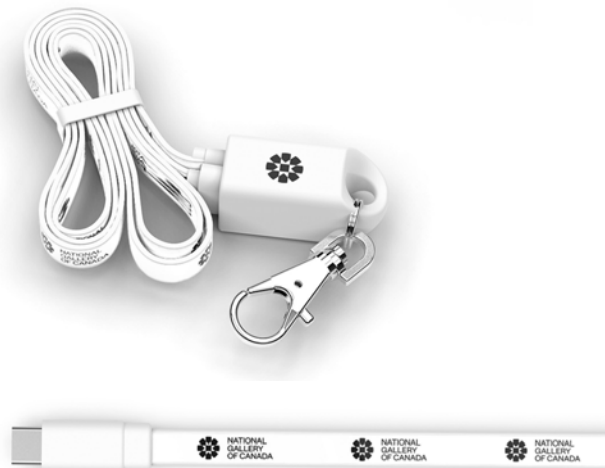

#### #94075 POWERSTICK LOOP+ TYPE C

- Portable USB C To USB A Cable
- Loops Around To Attach To Your Bag Or Keychain
- Cable Ends Join At Center Connector Piece To Form A Loop
- Suitable For Data Syncing And Charging Compatible Devices

#### #94076 POWERSTICK LANYARD

- Combination Charging Cable And Lanyard
- Central Hub Features A Metal Clip To Hold A Badge, Passkey, Name Badge, Etc.
- Charging And Data Syncing With Compatible Devices
- Cable Ends Get Stored In The Center Hub · Includes Metal Carabiner Clip
- 3 Foot USB C to USB A Cable With Apple® Tip
- Apple® MFi Certified Lightning® Adapter Tip
- Apple and Lightning are registered trademarks of Apple Inc., registered in the U.S. and other countries.

# LEGENDS

## Work Hard, Stay Humble

Pro-Athlete Tested Performance Wear. Built For The Modern Athlete.



- #LAT2 LEGENDS AVIATION TEE SPLIT HEM 2.0
- Everyday Essential For Effortless Style And Comfort
  - Classic Fit Tri-Blend Fabric With Split-Hem
  - Buttery Soft Feel
  - Unique 4-Way Stretch Provides Full Range Of Motion And Maintains Its Shape



- #LHQ1 LEGENDS HIGHLAND QUARTER ZIP
- Everyday Fleece For Any Occasion
  - Mid-Weight Cotton Knit · Ribbed Side Panel
  - Tapered Collar Quarter Zip
  - Legends Branded Zipper Pull



- #LHH2 LEGENDS HIGHLAND HOODIE
- Everyday Essential With A Sleek Silhouette
  - Soft Touch, 4-Way Stretch Fabric
  - Mid-Weight Cotton Blend Knit With Anti-Microbial Fabric
  - Ribbed Side Panel · Double Button Collar On Hood



# BRANDED BILLS



## #15047 BRANDED BILLS BARE CURVED PERFORMANCE CAP

- 92% Polyester, 8% Spandex
- Lightweight
- Sweat-Resistant Material
- 6 Panel, Low Profile
- Structured Crown & Pre-Curved Visor
- FlexFit® Sweatband
- Stretch For Comfort
- Perforated Back Panels For Breathability
- Adjustable Self Fabric Hook And Loop Closure
- Hand Wash Only



## #15050 BRANDED BILLS BARE ELITE CURVED CAP

- 92% Polyester, 8% Spandex
- Lightweight & Moisture Wicking
- Sweat And Water-Resistant
- 6 Panel, Mid Profile
- Structured Crown & Pre-Curved Visor
- Moisture Wicking Sweatband
- Perforated Back Panels For Breathability
- Adjustable Plastic Snap Tab Closure
- Hand Wash Only



## #15048 BRANDED BILLS BARE FLAT PERFORMANCE CAP

- 92% Polyester, 8% Spandex
- Lightweight & Sweat Wicking
- 6 Panel, High Profile
- Structured Crown & Flat Visor
- Stretch-Fit Sweatband
- Perforated Side & Back Panels For Breathability
- Adjustable Plastic Snap Tab Closure
- Branded Bills Style EP585
- Hand Wash Only



## #15049 BRANDED BILLS BARE ELITE CLASSIC CAP

- 92% Polyester, 8% Spandex
- Lightweight & Moisture Wicking
- 6 Panel, Mid Profile
- Sweat And Water-Resistant
- Structured Crown & Flat Visor
- Moisture Wicking Sweatband
- Perforated Side & Back Panels For Breathability
- Adjustable Plastic Snap Tab Closure
- Hand Wash Only

# HEADWEAR



- FLEXFIT** #15045 YP CLASSICS® CLASSIC DAD CAP
- 100% Cotton
  - 6 Panel, Low Profile
  - Unstructured Crown & Pre-Curved Visor
  - Adjustable Self-Material Strap With Sliding Buckle

- Made with Recycled Materials** #15055 ROOKIE RECYCLED PERFORMANCE CAP
- 100% Recycled Polyester Taslon
  - Made From Post Consumer Recycled Materials
  - Lightweight & Durable · Moisture Wicking
  - 6 Panel, Low Profile · Unstructured Crown & Pre-Curved Visor
  - Adjustable Self-Material Strap With Hook & Loop Closure



- #15056 TRENT TENCEL™ CAP
- 55% Cotton, 45% Tencel™ Fabric
  - Tencel™ Fabric Is Made From Sustainably Sourced Wood Fibers
  - Soft, Durable & Breathable
  - Hypoallergenic, Suitable For Sensitive Skin
  - 5 Panel, Mid Profile · Structured Crown & Pre-Curved Visor
  - Recycled Plastic Snap Tab Closure



#15059 WINSLOW WOOL CAP

- 100% Woolen Polyester With Polyester Oxford Interlining, Sweatband & Inner Tape
- 5 Panel, Medium Profile
- Structured Crown & Pre-Curved Visor
- Adjustable Self-Material Strap With Sliding Buckle



#15057 TUCKER TENCEL™ TRUCKER CAP

- 55% Cotton, 45% Tencel™ Fabric, Back
- Tencel™ Fabric Is Made From Sustainably Sourced Wood Fibers
- 6 Panel, Mid Profile · Structured Crown & Pre-Curved Visor
- 100% Recycled Polyester Mesh Back
- Recycled Plastic Snap Tab Closure



#15058 REPLAY RPET CAP

- rPET Polyester Crown, Visor & Back Panels
- Recycled Polyester (rPET) is Obtained By Melting Down Existing Plastic Bottles And Other Material Sources To Create New Polyester Fiber
- Made From Post Consumer Recycled Materials
- 6 Panel, Mid Profile · Structured Crown & Pre-Curved Visor
- Perforated Back Panels For Breathability · Plastic Snap Tab Closure
- Sweatband, Seam Tape & Snap Tab Closure Are Not rPET



#15062 PRODIGY PERFORMANCE FLEX CAP

- 96% Polyester, 4% Spandex & 100% Polyester Back
- Sweatband 92% Polyester, 8% Spandex
- Moisture Wicking
- 100% Cotton Seam Tape
- 6 Panel, Medium Profile
- Adjustable Band For Sizes Up To XL - 62 cm
- Structured Crown & Pre-Curved Visor
- Laser Perforated Side & Back Panels For Breathability
- Adjustable Self-Material Strap With Hook & Loop Closure



- #15044 AIRMESH TRUCKER CAP
- 97% Polyester/3% Spandex · 6 Panel, Mid Profile
  - Structured Crown & Pre-Curved Visor
  - Mesh Back With Adjustable Plastic Snap Tab Closure



- #15061 LUXE PLUSH RECYCLED BEANIE
- Made Of 74% Recycled Polyester, 22% Acrylic, 4% Elastane
  - Buttery Soft Feel Of Cashmere
  - One Size Fits Most
  - Unisex



Optional imprint area shown



- #15065 TOUCH SCREEN GLOVES IN RPET POUCH
- Gloves Made Of 50% Acrylic, 50% rPET/Polyester/Spandex/Conductive Yarn
  - rPET Drawstring Pouch With J-Hook Attachment
  - Made From Post Consumer Recycled Materials
  - Recycled Polyester (rPET) Is Obtained By Melting Down Existing Plastic Bottles And Other Material Sources To Create New Polyester Fiber
  - Drawstring Cord, Cord Lock And J-Hook Attachment Are Not rPET
  - Use Your Touch Screen Devices Without Having To Remove Your Gloves
  - Includes 3 Touch Fingers With Acrylic Tips (Thumb, Index And Middle Fingers)
  - Long Cuff For Extended Coverage · Unisex · One Size Fits Most



#15066



#70002



**#70002 ISLIDE STATEMENT SOCKS**

- Matches The Same Quality, Comfort And Attention To Detail As The Classic #MCORE ISlide Mantra Slide Style
- Offers Premium Quality And Exceptional Durability
- Features Added Arch And Ankle Support
- Wrapped Up With Moisture Wicking, Antimicrobial Properties To Help Stop The Stink
- Excluded From EQP

**#15066 COZY CABLE KNIT SLIPPER SOCKS**

- Made Of 100% Acrylic With 100% Polyester Sherpa Lining
- One Size Fits Most
- Non-Skid Grips On Foot
- Unisex
- Price Includes 1-Location Embroidery On One Sock



# BAGS



## #30112 XL ANYWHERE BELT BAG

- Made of 230D Twill Polyester With 240D Twill Polyester Lining
- Can Be Worn As A Fanny Pack Or As A Chest Sling
- Zippered Main Compartment
- Back Zippered Pocket
- 2 Interior Mesh Pockets
- Adjustable Waist Strap With Elastic Loop On Belt's End
- Spot Clean/Air Dry



## #35125 RIDLEY RPET SLING BAG

- Made Of 230T rPET Polyester With 190T Lining
- Made From Post Consumer Recycled Materials
- Recycled Polyester (rPET) Is Obtained By Melting Down Existing Plastic Bottles And Other Material Sources To Create New Polyester Fiber
- Lining, Zipper, Shoulder Strap, Inside Binding, Piping, Buckle and Label Are Not rPET
- Zippered Main Compartment
- Adjustable Shoulder Strap
- Spot Clean/Air Dry



## #35134 CALEB RPET CONVERTIBLE BACKPACK AND SLING BAG

- Made Of 230D Twill rPET With 210D Polyester Lining And EVA Foam
- Made From Post Consumer Recycled Materials
- Recycled Polyester (rPET) Is Obtained By Melting Down Existing Plastic Bottles And Other Material Sources To Create New Polyester Fiber
- Lining, Inside Foam, Zipper, Binding, Handle, Buckle and Label Are Not rPET
- Zippered Main Compartment · Front Zippered Pocket
- Zippered Straps Convert to Backpack Or Sling Bag
- Straps Clip To One Side To Convert to Sling Bag
- Adjustable Shoulder Straps · Spot Clean/Air Dry



## #35133 CHLOE CLEAR CROSSBODY SLING BAG

- Made Of Combo: EVA And 600D Polyester
- EVA Is Phthalate-Free And Has Better Thermal Resistance And Tensile Toughness Than PVC
- Adjustable Padded Shoulder Sling And Web Carrying Handle
- Double Zippered Main Compartment
- Front Zippered Pocket · 1 Side Mesh Pocket · Spot Clean/Air Dry



#30149 ELLE EASY CARRY PADFOLIO

- Includes 30 Page Lined 8 1/2" x 11" Writing Pad
- Recycled Polyurethane Cover With 300D rPET Lining
- Cover Made From Post Consumer Recycled Materials
- Recycled Polyester (rPET) Is Obtained By Melting Down Existing Plastic Bottles And Other Material Sources To Create New Polyester Fiber
- Cover, Pocket Lining, Elastic Pen Holder, Zipper, Notepad, Paper, Elastic Band, Paperboard And Label Are Not rPET
- Elastic Pen Loop, 4 Card Slots, 3 Interior Slip Pockets And Mesh ID Holder
- 1 Large Interior Slip Pocket, 3 Small Interior Slip Pockets, 4 Interior Card Slots, 1 Interior Slip Phone Pocket And Elastic Pen Loop
- Interior Phone Pocket Can Hold Most Smartphones · FSC® Certified
- FSC® Certified Products Are Made With, Or Contain, Forest-Based Materials Sourced From Forests That Have Been Audited By An Independent Third Party To Confirm They Are Managed According To FSC®'s Rigorous Social And Environmental Standards.



The mark of responsible forestry

#30146 EXECUTIVE RPET TOTE BAG

- Made Of rPET Microfiber With 75D Polyester Lining
- Made From Post Consumer Recycled Materials
- Recycled Polyester (rPET) Is Obtained By Melting Down Existing Plastic Bottles And Other Material Sources To Create New Polyester Fiber
- Lining, Inside Foam, Zipper, Binding, Handle And Label Are Not rPET
- Large Open Main Compartment With Snap Closure
- Front Zippered Pocket · Padded Laptop Sleeve
- Accommodates Most Laptops Up To 15"
- Trolley Strap To Fit Over Your Luggage
- Spot Clean/Air Dry



#30125 LAUREN TOTE BAG

- Made Of 230D Twill Polyester With 190T Polyester And Non-Woven Polypropylene Lining
- Top Zippered Closure
- Leatherette Accents
- Interior Pockets And Elastic Straps For Organization
- Spot Clean/Air Dry



#30133 POLLY LARGE SHOPPER TOTE BAG

- Made Of Combo: 14 Oz. Polyester And EVA With 230T Polyester Lining
- Great For Grocery Stores, Markets, Book Stores, Etc.
- Reusable
- Spot Clean/Air Dry

#35130 MARLEY RPET TOTE BAG WITH COOLER COMPARTMENT

- Made Of Combo: 600D rPET And Polyester Mesh
- Made From Post Consumer Recycled Materials
- Recycled Polyester (rPET) Is Obtained By Melting Down Existing Plastic Bottles And Other Material Sources To Create New Polyester Fiber
- Mesh, Lining, Zipper, Handle And Label Are Not rPET
- Zippered Main Compartment
- Double Zippered Drop Bottom Cooler Compartment With PEVA Lining And EPE Foam
- Holds Up To 12 Cans · Front Slip Pocket · Spot Clean/Air Dry



#30131 INTREPID RPET TOTE BAG

- Made Of 230D rPET Polyester With 190T Polyester Lining
- Made From Post Consumer Recycled Materials
- Recycled Polyester (rPET) Is Obtained By Melting Down Existing Plastic Bottles And Other Material Sources To Create New Polyester Fiber
- Zipper, Handle, Shoulder Strap And Bottom Are Not rPET
- Zippered Main Compartment
- Detachable/Adjustable Shoulder Strap
- Padded Laptop Pocket Inside
- Web Carrying Handles
- Accommodates Most Laptops Up To 13"
- 2 Front Slip Pockets
- Front Slip Pocket Can Accommodate 40 Oz. Intrepid Tumbler
- Interior Zip Pocket
- Interior Slip Pockets
- Spot Clean/Air Dry





#30144

#30144 FORESTER DELUXE TOTE BAG

- Made Of Combo: 150D rPET And Polypropylene With 210D Polyester Lining
- Made From Post Consumer Recycled Materials
- Recycled Polyester (rPET) is Obtained By Melting Down Existing Plastic Bottles And Other Material Sources To Create New Polyester Fiber
- Zipper, Handle, Shoulder Strap And Bottom Are Not rPET
- Zippered Main Compartment · Front Zippered Pocket
- Trolley Sleeve To Fit Over Your Luggage · Spot Clean/Air Dry



#3243 LARGE STARBOARD RECYCLED COTTON CANVAS TOTE BAG

- Made Of 19 Oz. Recycled Cotton Canvas
- 600 GSM Recycled Canvas And 140 GSM Recycled Cotton
- Zippered Main Compartment · Spot Clean/Air Dry



#3238 SMALL STARBOARD RECYCLED COTTON CANVAS TOTE BAG

- Made Of Combo: 10 Oz. 70% Recycled Cotton Canvas And 30% Polyester
- Front Pocket · Spot Clean/Air Dry



#3243



#3238



- #30115 RIPLEY RECYCLED COTTON STARBOARD TOTE BAG
- Made Of Combo 10 Oz. 80% Recycled Cotton Canvas And 20% Recycled Polyester
  - 320 GSM · Front Slip Pocket
  - Spot Clean/Air Dry



- #3244 ARDEN RECYCLED COTTON STARBOARD TOTE BAG
- Made Of Combo: 9 Oz. 60% Recycled Cotton And 40% Recycled Polyester
  - 300 GSM
  - Front Slip Pocket
  - Spot Clean/Air Dry



- #33200 ARDEN RECYCLED COTTON CANVAS TOTE BAG
- Made Of Combo: 3 Oz. 70% Recycled Cotton And 30% Recycled Polyester
  - 140 GSM
  - Large Open Main Compartment
  - Spot Clean/Air Dry



#30111 JULIA JUTE TOTE BAG

- Made of Combo: 10 Oz. Cotton Canvas And Laminated Jute, A Natural Vegetable Fiber
- Large Open Main Compartment
- Front Slip Pocket
- Spot Clean/Air Dry



#30147 SWOOP HEATHERED RPET TOTE BAG

- Made Of Combo: 300D Heathered rPET And 300D Polyester With 210D Polyester Lining
- Made From Post Consumer Recycled Materials
- Recycled Polyester (rPET) Is Obtained By Melting Down Existing Plastic Bottles And Other Material Sources To Create New Polyester Fiber
- Interior Lining, Handle, Binding And Label Are Not rPET
- Front Slip Pocket · Spot Clean/Air Dry



#30145 MELISSA TOTE BAG

- Made Of Combo: 600D Polyester With Shiny Webbing
- Cotton Alternative With Cotton Feel
- Large Open Main Compartment
- Spot Clean/Air Dry



#30110 JUMBO LOLA LAMINATED NON-WOVEN TOTE BAG

- Made Of Combo: 80 Gram Non-Woven, Coated Water-Resistant Polypropylene And Laminated rPET
- Made From Post Consumer Recycled Materials
- Recycled Polyester (rPET) is Obtained By Melting Down Existing Plastic Bottles And Other Material Sources To Create New Polyester Fiber
- Lamination Is Not rPET · Reusable · Spot Clean/Air Dry

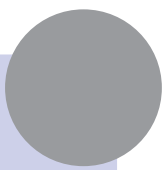



#30138 TERRY TOTE BAG  
 · Made Of 100% Polyester  
 · Terry Fabric Front Face With White Cotton Backing  
 · Spot Clean/Air Dry



#32002 JONES RECYCLED COTTON TOTE BAG  
 · Made Of 4 Oz. Recycled 100% Natural Cotton  
 · 140 GSM · Spot Clean/Air Dry



#30098 HEMP TOTE BAG  
 · Made Of 100% Hemp  
 · Hemp Is Considered A Sustainable Resource. It Requires Less Water And Energy To Be Grown And Is Long Lasting  
 · Large Open Main Compartment  
 · Spot Clean/Air Dry



#30134 ROWAN RPET NON-WOVEN SHOPPER TOTE BAG  
 · Made Of Non-Woven rPET · 95 GSM  
 · Made From Post Consumer Recycled Materials  
 · Recycled Polyester (rPET) is Obtained By Melting Down Existing Plastic Bottles And Other Material Sources To Create New Polyester  
 · Label Is Not rPET · Reusable · Spot Clean/Air Dry





#30126 MABLE VALUE TOTE

- Made Of 80 Gram Non-Woven, Coated Water-Resistant Polypropylene
- Great For Grocery Stores, Markets, Book Stores, Gift Bags, Etc.
- Reusable
- Spot Clean/Air Dry



#30087 PISCES RPET NON-WOVEN TOTE BAG

- Made Of Combo: 80 Gram Non-Woven, PET And rPET
- Made From Post Consumer Recycled Materials
- Recycled Polyester (rPET) Is Obtained By Melting Down Existing Plastic Bottles And Other Material Sources To Create New Polyester Fiber
- Mesh Pocket Is Not rPET
- Front Slip Pocket
- Front Mesh Pocket
- Reusable
- Spot Clean/Air Dry





#30117 LAGUNA BEACH CLEAR TOTE BAG

- Made Of Combo: EVA And Polyester
- EVA Is Phthalate-Free And Has Better Thermal Resistance And Tensile Toughness Than PVC
- Zippered Main Compartment
- Spot Clean/Air Dry



#30120 COLBY TRANSPARENT TOTE BAG

- Made Of PVC
- Spot Clean/Air Dry
- Large Open Main Compartment



Reflective Piping

REFLECTIVE SHOPPER

#33612 REFLECTIVE SHOPPER CLEAR EVA REFLECTIVE TOTE BAG

- Made Of Combo: EVA And Polyester
- EVA Is Phthalate-Free And Has Better Thermal Resistance And Tensile Toughness Than PVC
- Patented Reflective Piping
- Meets NFL Sizing Guidelines
- Spot Clean/Air Dry



#33603



#33604

- #33603 CLEAR EVA TOTE BAG WITH ZIPPER
- Made Of Combo: EVA And Polypropylene
  - EVA Is Phthalate-Free And Has Better Thermal Resistance And Tensile Toughness Than PVC
  - Zippered Main Compartment
  - Meets NFL Sizing Guidelines
  - Spot Clean/Air Dry

- #33604 CLEAR CASUAL EVA TOTE BAG
- Made Of Combo: EVA And Polyester
  - EVA Is Phthalate-Free And Has Better Thermal Resistance And Tensile Toughness Than PVC
  - Spot Clean/Air Dry

- #33600 CLEAR EVA TOTE BAG
- Made Of Combo: EVA And Polyester
  - EVA Is Phthalate-Free And Has Better Thermal Resistance And Tensile Toughness Than PVC
  - Meets NFL Sizing Guidelines
  - Spot Clean/Air Dry



#33600



#33602



#33606



#33601

**#33602 CLEAR EVA DRAWSTRING BACKPACK**

- Made Of Combo: EVA And 600D Polyester
- EVA Is Phthalate-Free And Has Better Thermal Resistance And Tensile Toughness Than PVC
- Reinforced Eyelets
- Matching Drawstring And Colored Trim
- Drawstring Closure
- Spot Clean/Air Dry

**#33606 TOUCHDOWN CLEAR EVA DRAWSTRING BACKPACK**

- Made Of Combo: EVA And 600D Polyester
- EVA Is Phthalate-Free And Has Better Thermal Resistance And Tensile Toughness Than PVC
- Meets NFL Sizing Guidelines
- Reinforced Eyelets
- Matching Drawstring And Colored Trim
- Drawstring Closure
- Spot Clean/Air Dry

**#33601 CLEAR EVA BACKPACK**

- Made Of Combo: EVA And 600D Polyester
- EVA Is Phthalate-Free And Has Better Thermal Resistance And Tensile Toughness Than PVC
- Adjustable Padded Shoulder Straps And Web Handle
- Double Zippered Main Compartment
- Front Zippered Pocket · 2 Side Mesh Pockets · Spot Clean/Air Dry



**#35114 EVANSTON BACKPACK**

- Made Of Combo: Matte Polyurethane And 450D Polyurethane With 210D Polyurethane Lining
- Adjustable Padded Shoulder Straps And Web Carrying Handles
- Double Zippered Main Compartment
- Front Slip Pocket · Interior Slip Pocket · Spot Clean/Air Dry



**#35122 DRIFT ROLL-TOP BACKPACK**

- Made Of Matte 40C Tarpaulin PVC With 210D Polyurethane Polyester Lining
- Adjustable Padded Shoulder Straps And Web Carrying Handle
- Roll-Top Main Compartment With Top And Side Buckle Closures
- Air Mesh Padded Back · 2 Front Zippered Pockets
- Interior Laptop Sleeve · Accommodates Most Laptops Up To 14"
- Mesh Side Pocket · Spot Clean/Air Dry



**#324I ARDEN RECYCLED COTTON BACKPACK**

- Made Of 14 Oz. Recycled Cotton Canvas
- Zippered Main Compartment · 300 GSM
- Adjustable Padded Shoulder Straps And Padded Carrying Handle
- Front Zippered Pocket · Interior Laptop Pocket
- Accommodates Most Laptops Up To 14" · Spot Clean/Air Dry



**#35132 SOPHIE 3-IN-1 CONVERTIBLE RPET BACKPACK**

- Made Of 600D Heathered rPET Material With 190T Polyester Lining
- Made From Post Consumer Recycled Materials Recycled Polyester (rPET) Is Obtained By Melting Down Existing Plastic Bottles And Other Material Sources To Create New Polyester Fiber
- Foam, Lining, Zipper, Handle, Shoulder, Binding And Label Are Not rPET
- Top & Side Carrying Handles · Adjustable Stowable, Padded Shoulder Straps
- Double Zippered Main Compartment
- Padded Laptop Sleeve With Hook And Loop Closure
- Large Double Zippered Front Pocket · Small Front Zippered Pocket
- Accommodates Most Laptops Up To 15"
- Can Be Worn As A Backpack, Messenger Bag Or Briefcase
- Spot Clean/Air Dry





Backpack Folds Into Pouch



#35124 ALPINE RPET BACKPACK

- Made Of Combo: 190T rPET And PU Ripstop Polyester With 210D rPET Lining
- Made From Post Consumer Recycled Materials
- Recycled Polyester (rPET) Is Obtained By Melting Down Existing Plastic Bottles And Other Material Sources To Create New Polyester Fiber
- Buckle, Handle, Webbing Straps, Elastic Mesh Pockets, Zipper, Reflective Webbing Are Not rPET
- Double Zippered Main Compartment
- Adjustable Padded Shoulder Straps And Padded Web Carrying Handle
- Front Pocket With Buckle Closure · Side Mesh Pockets
- Stows Into Its Own Front Pocket For Travel · Spot Clean/Air Dry



#3242 ARDEN RECYCLED COTTON DRAWSTRING BAG

- Made Of Combo: 3 Oz. 70% Recycled Cotton And 30% Recycled Polyester
- 140 GSM · Drawstring Closure
- Can Be Carried As A Tote Bag Or Worn As A Drawstring Bag
- Spot Clean/Air Dry



#35123 JOEL RPET DRAWSTRING TOTE BAG

- Made Of Combo: 230D rPET And Twill Polyester with PU Backing And Polyester Webbing
- Made From Post Consumer Recycled Materials
- Recycled Polyester (rPET) Is Obtained By Melting Down Existing Plastic Bottles And Other Material Sources To Create New Polyester Fiber
- Handle, Shoulder, Inside Binding and Label Are Not rPET
- Drawstring Closure
- Can Be Carried As A Tote Bag Or Worn As A Drawstring Bag
- Spot Clean/Air Dry



#35108



Phone not included



#35118



#### #35108 ANYWHERE RPET BACKPACK

- Made of Combo: 230D rPET And Twill Polyester With 190T Polyester Lining
- Made From Post Consumer Recycled Materials
- Recycled Polyester (rPET) Is Obtained By Melting Down Existing Plastic Bottles And Other Material Sources To Create New Polyester Fiber
- Zipper, Handle, Inner Binding, Buckle and Padding Are Not rPET
- Zippered Main Compartment
- Adjustable Shoulder Straps And Web Carrying Handle
- Front Zippered Pocket
- 2 Side Slip Pockets
- Trolley Strap To Fit Over Your Luggage
- Padded Laptop Pocket Inside
- Accommodates Most Laptops Up To 13"
- Zinc Alloy Zippers
- Polyester Webbing Zipper Pulls
- Spot Clean/Air Dry

#### #35118 HABITAT RPET HEATHERED SLING BAG

- Made Of 300D Heathered rPET Material With 190T Polyester Lining
- Made From Post Consumer Recycled Materials
- Recycled Polyester (rPET) Is Obtained By Melting Down Existing Plastic Bottles And Other Material Sources To Create New Polyester Fiber
- Inside Lining, Foam, Binding, Zipper And Care Label Are Not rPET
- Zippered Main Compartment
- Side Zippered Pocket
- Adjustable Padded Shoulder Sling And Web Carrying Handle
- Spot Clean/Air Dry



#30122



#30124



Contents not included



#30123



**#30122 HABITAT RPET HEATHERED TOTE BAG**

- Made Of 300D Heathered rPET Material
- Made From Post Consumer Recycled Materials
- Recycled Polyester (rPET) Is Obtained By Melting Down Existing Plastic Bottles And Other Material Sources To Create New Polyester Fiber
- Zipper And Label Are Not rPET · Front Zippered Pocket
- Spot Clean/Air Dry

**#30124 HABITAT RPET HEATHERED TECH POUCH**

- Made Of 300D Heathered rPET Material And Mesh With 190T Polyester Lining
- Made From Post Consumer Recycled Materials
- Recycled Polyester (rPET) Is Obtained By Melting Down Existing Plastic Bottles And Other Material Sources To Create New Polyester Fiber
- Inside Lining, Inside Foam, Inside Mesh Pocket, Inside Elastic Band, Binding, Zipper And Label Are Not rPET
- Zippered Main Compartment · Front Zippered Pocket
- Interior Pockets And Elastic Straps For Organization
- Spot Clean/Air Dry

**#30123 HABITAT RPET HEATHERED DUFFEL BAG**

- Made Of 300D Heathered rPET Material With 190T Polyester Lining
- Made From Post Consumer Recycled Materials
- Recycled Polyester (rPET) Is Obtained By Melting Down Existing Plastic Bottles And Other Material Sources To Create New Polyester Fiber
- Inside Lining, Inside Foam, Binding, Handle Shoulder, Zipper And Label Are Not rPET
- Detachable/Adjustable Padded Shoulder Strap
- Web Carrying Handles With Hook And Loop Closure Comfort Grip
- Double Zippered Main Compartment
- Front Zippered Pocket
- Back Zippered Pocket
- Spot Clean/Air Dry



**#30142 HUDSON RPET LEATHERETTE DUFFEL BAG**

- Made Of Combo: 85% rPET Foggy PU & 210D Polyester
- 4MM PE Foam Lining
- Made From Post Consumer Recycled Materials
- Recycled Polyester (rPET) is Obtained By Melting Down Existing Plastic Bottles And Other Material Sources To Create New Polyester Fiber
- Inside Lining, Inside Foam, Binding, Zipper, Handle And Label Are Not rPET
- Double Zippered Main Compartment
- Adjustable/Detachable Shoulder Strap And 23" Web Carrying Handles
- Interior Zippered Pocket
- Front Zippered Pocket
- Spot Clean/Air Dry



**#30118 WANDERLUXE DUFFEL BAG**

- Made Of 230D Twill Polyester With Matte Polyester Lining
- Padded Front, Back And Bottom Panels
- Double Zippered Main Compartment
- Front Zippered Compartment With Outside Zippered Pocket
- Adjustable/Detachable Padded Shoulder Strap
- Web Carrying Handles
- Back Zippered Pocket
- 2 Side Slip Pockets
- 2 Interior Zippered Pockets
- Trolley Sleeve To Fit Over Your Luggage
- Spot Clean/Air Dry



**#30128 THE WEEKENDER CONVERTIBLE LAPTOP BAG WITH REMOVABLE DROP BOTTOM**

- Made Of Combo: High Density Compound Polyester And Matte PU With 210D Polyester Lining And Polyethylene Foam
- Double Zippered Main Compartment
- Easy-Access Opening
- Double Zippered Drop-Bottom Compartment To Keep Your Shoes, Toiletries And Travel Essentials Separate
- Convertible And Removeable Zip-Off Bottom
- Detachable Padded Shoulder Strap And Carrying Handles
- Front Zippered Pocket
- Interior Slip Pocket
- Padded Laptop Sleeve
- Accommodates Laptops Up To 12"
- Back Zippered Pocket Turns Into Trolley Sleeve To Fit Over Your Luggage
- Tone-On-Tone Color Enhances Design
- Spot Clean/Air Dry



**#30139 KYLE RPET DUFFEL BAG WITH DROP BOTTOM**

- Made Of 240T rPET With 190T Polyester Lining
- Made From Post Consumer Recycled Materials
- Recycled Polyester (rPET) Is Obtained By Melting Down Existing Plastic Bottles And Other Material Sources To Create New Polyester Fiber
- Foam, Lining, Zipper, Handle, Shoulder And Binding Are Not rPET
- Double Zippered Main Compartment
- Double Zippered Drop-Bottom Compartment To Keep Your Shoes, Toiletries And Travel Essentials Separate
- Adjustable/Detachable Shoulder Strap And Carrying Handles
- Front Pocket With Magnetic Closure
- Side Mesh Pockets
- Trolley Sleeve To Fit Over Your Luggage
- Spot Clean/Air Dry





#30137



#30143



#30130



**#30137 GLEN LEATHERETTE TOILETRY BAG**

- Made Of Polyurethane With Polyester and EVA Lining
- Zippered Main Compartment And Carrying Handle
- Front Zippered Pocket
- Spot Clean/Air Dry

**#30143 HUDSON LEATHERETTE COSMETIC BAG**

- Made Of Combo: 85% rPET Foggy PU & 210D Polyester
- 2MM PE Foam Lining
- Made From Post Consumer Recycled Materials
- Recycled Polyester (rPET) is Obtained By Melting Down Existing Plastic Bottles And Other Material Sources To Create New Polyester Fiber
- Inside Lining, Inside Foam, Binding, Zipper, Handle And Label Are Not rPET
- Zippered Main Compartment
- Double Zippered Bottom Compartment
- Handle For Easy Carrying · 2 Interior Slip Pockets
- Spot Clean/Air Dry

**#30130 ATLANTICA COLOR POP POUCH**

- Made Of Combo: Polyester And EVA
- Neoprene Look And Feel
- Zippered Main Compartment
- Internal Metal Wire Opening Allows For Easy Access And Prevents The Pouch From Collapsing On Itself
- Spot Clean/Air Dry



#3875



**#3875 ARDEN RECYCLED COTTON TOILETRY BAG**

- Made Of Combo: 2 Oz. 60% Recycled Cotton And 40% Recycled Polyester
- 300 GSM
- Zippered Main Compartment
- Handle For Easy Carrying
- Spot Clean/Air Dry



#30129



**#30129 RAY RPET POUCH**

- Made Of 600D rPET Polyester
- Made From Post Consumer Recycled Materials
- Recycled Polyester (rPET) Is Obtained By Melting Down Existing Plastic Bottles And Other Material Sources To Create New Polyester Fiber
- Zipper And Labels Are Not rPET
- Zippered Main Compartment
- Tone-On-Tone Color Enhances Design
- Spot Clean/Air Dry



#30135



**#30135 CAMILA CLEAR TOILETRY BAG**

- Made Of Combo: Clear 30C PVC and 600D rPET With 210D Polyester Lining
- Made From Post Consumer Recycled Materials
- Recycled Polyester (rPET) is Obtained By Melting Down Existing Plastic Bottles And Other Material Sources To Create New Polyester Fiber
- Body, Lining And Zipper Are Not rPET
- Zippered Main Compartment · Carrying Handle
- Spot Clean/Air Dry

#30150 CHELSEA PUFFER WRISTLET POUCH

- Made Of Water-Resistant Nylon With 210D PU And Velvet Material Lining
- Velvet Material Lining
- Zippered Main Compartment
- Wrist Strap For Easy Carrying
- Spot Clean/Air Dry



#30119 LANA RPET WRISTLET POUCH

- Made Of Combo: 230D rPET, Twill Polyester And Polypropylene Webbing
- Recycled Polyester (rPET) is Obtained By Melting Down Existing Plastic Bottles And Creating New Polyester Fiber
- Wrist Strap, Zipper, Webbing And Lining, Are Not rPET
- Zippered Main Compartment
- O-Ring Attachment
- Detachable Wrist Strap
- Spot Clean/Air Dry



#30127 DUAL RPET POUCH SET

- Set Includes #30097 Reed rPET Card Pouch And #30119 Lana rPET Wristlet Pouch
- Pricing Includes 1-Color/1-Location Imprint On Each Item





#30116  
Tools Not Included



#30153

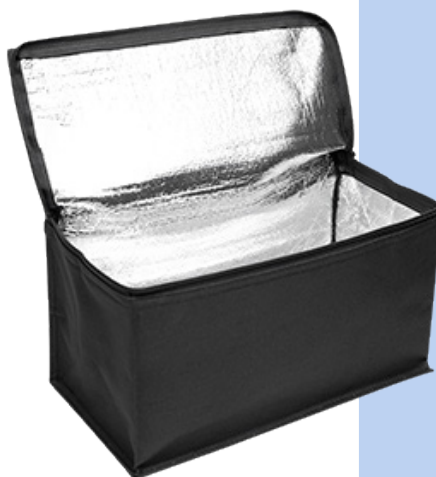

#30116 TREKKER RPET TOOL BAG

- Made Of 600D rPET With 210D Polyester Lining And EPE Foam
- Made From Post Consumer Recycled Materials
- Recycled Polyester (rPET) Is Obtained By Melting Down Existing Plastic Bottles And Other Material Sources To Create New Polyester Fiber
- Lining, Foam, Shoulder, Zipper, Button Are Not rPET
- Web Carrying Handles With Snap Closure
- Internal Metal Frame Opening Allows For Easy Access And Prevents The Bag From Collapsing On Itself
- Zippered Main Compartment
- Large Front Slip Pocket
- Interior Zippered Pocket
- Spot Clean/Air Dry

#30153 TRUNK ORGANIZER WITH COOLER BAG

- Made Of 600D Polyester With 210D Lining
- Cardboard And PE Foam Sides And Cardboard Bottom Gussets Help Keep Organizer Sturdy
- Includes Foil Laminated PE Foam Insulated Cooler Bag
- Cooler Sold As Shown
- 3 Compartments · Structured Sides And Bottom Gusset
- Side Carrying Handles
- Side Slip Pocket
- Side Mesh Pocket
- Folds Flat And Stays Closed With Hook Loop Closure For Convenient Travel & Storage
- Use As A Trunk Organizer, Shopper Tote Or For Storage
- Spot Clean/Air Dry



- #30152 KRAFT PAPER ZIPPERED POUCH**
- Made of Combo: Kraft Paper And PVC
  - Zippered Main Compartment
  - Clear Window On Front
  - Supports Responsible Forestry
  - FSC® Certified
  - FSC® Certified Products Are Made With, Or Contain, Forest-Based Materials Sourced From Forests That Have Been Audited By An Independent Third Party To Confirm They Are Managed According To FSC®'s Rigorous Social And Environmental Standards.



#30152



#30140



Contents Not Included



#75067



- #75067 PROTECTIVE CASE WITH CARABINER**
- Made Of Combo: EVA, PU And Polyester Mesh
  - Double Zippered Main Compartment
  - Interior Mesh Pocket · Carabiner Attachment
  - Protective Travel Case For Convenient Travel
  - Spot Clean/Air Dry



- #30140 INTREPID 40 OZ. TUMBLER SLING WITH POUCH**
- Made Of Combo: rPET And Neoprene
  - Made From Post Consumer Recycled Materials
  - Recycled Polyester (rPET) Is Obtained By Melting Down Existing Plastic Bottles And Other Material Sources To Create New Polyester Fiber
  - Zipper And Strap Are Not rPET · Front Zippered Pocket
  - Front Slip Pocket · Hook And Loop Closure
  - Adjustable/Removable 57" Padded Shoulder Strap
  - Fits Standard 40 Oz. Tumblers · Spot Clean/Air Dry



**#35017 CLARK 28 CAN COOLER LUNCH BAG**

- Made Of 70D Nylon With 600D Polyester Bottom
- White PEVA Lining
- Detachable/Adjustable Shoulder Strap And Web Carrying Handles With Hook And Loop Comfort Grip
- Front Zippered Pocket
- Zippered Main Compartment
- Holds Up To 28 Cans
- Spot Clean/Air Dry



**#35107 CHROMATIC 8 CAN COOLER LUNCH BAG**

- Made Of Combo: 210D PU and PE Foam
- 12C Silver PEVA Lining
- Zippered Main Compartment
- Web Carrying Handles With Hook And Loop Comfort Grip
- Front Slip Pocket
- Holds Up To 8 Cans
- Spot Clean/Air Dry



**#35112 TO-GO 20 CAN COOLER BAG**

- Made Of Combo: High Density 600D Polyester And EVA
- Gray PEVA Lining With EPE Foam Insulation
- Adjustable Padded Shoulder Strap And Web Carrying Handles
- Double Zippered Main Compartment
- Front Slip Pocket
- Hard-Cell Insulation On Top And Bottom
- Front Dual Loops Perfect For Attaching Carabiners
- Built To Hold It's Shape And Protect Your Lunch During Travel
- Holds Up To 20 Cans Of Your Favorite Beverage Without Ice
- Spot Clean/Air Dry





- #35113 CADY 6 BOTTLE COOLER TOTE BAG
- Made Of Combo: 300D Polyester and PE Foam
  - White PEVA Lining
  - Adjustable Carrying Strap Includes Built-In Bottle Opener
  - Zippered Main Compartment
  - Front Slip Pocket
  - Holds 6 Pack Carton Of Your Favorite Bottled Beverage
  - Spot Clean/Air Dry



· Bottles not includedd



- #35120 - 6 PACK COOLER BAG
- Made Of 600D Polyester
  - 12C Silver PEVA Lining
  - Zippered Main Compartment
  - Front Pocket
  - Side Mesh Pocket With Drawstring Closure
  - Side Pocket With Hook And Loop Closure Flap
  - Holds Up To 6 Cans
  - Adjustable 36" Shoulder Strap
  - Spot Clean/Air Dry



· Contents not included

- #35111 DUAL HANDLE LUNCH BAG
- Made Of 600D Polyester
  - Gray PEVA Lining
  - Double Zippered Main Compartment
  - Front Zippered Pocket
  - Detachable Top Handle To Easily Carry Your Lunch Upright
  - Features Handle On Front Of Bag, Perfect For Carrying Bento Boxes
  - Spot Clean/Air Dry



BioShield

**#35131 ASHTON RPET COOLER TOTE BAG**

- Made Of 600D rPET · Gray PEVA Lining · Made From Post Consumer Recycled Materials
- Recycled Polyester (rPET) is Obtained By Melting Down Existing Plastic Bottles And Other Material Sources To Create New Polyester Fiber
- Lining, Handle, Binding And Zipper Are Not rPET · Zippered Main Compartment
- Front Slip Pockets · Spot Clean/Air Dry



union

Bottle not included

**#35087 DIMPLES RPET NON-WOVEN COOLER TOTE BAG**

- Made Of Combo: 80 Gram Non-Woven, Coated Water-Resistant Polypropylene And rPET
- Foil Laminated PE Foam Insulation
- Made From Post Consumer Recycled Materials
- Recycled Polyester (rPET) is Obtained By Melting Down Existing Plastic Bottles And Other Material Sources To Create New Polyester Fiber
- Lining, Mesh, Zipper, Label Are Not rPET · Zippered Main Compartment
- Side Mesh Pocket · Spot Clean/Air Dry



**#30079 DOUBLE BOTTLE BEACH COOLER**

- Made Of 600D Polyester · Gray PEVA Lining
- Adjustable Shoulder Strap · Front Slip Pocket · Interior Divider Insert
- Holds Two Standard Size Wine Bottles Or Two 2-Liter Bottles
- Spot Clean/Air Dry





#35115



#35116



#35117

**#35115 KOOL PAK® 12 CAN COOLER BAG**

- Made Of 420D Polyester
- 12C Gray PEVA Lining With 6MM PE Foam
- Zippered Main Compartment
- Front Zippered Pocket
- 2 Side Mesh Pockets
- Adjustable Shoulder Strap And Padded Web Carrying Handle
- Holds Up To 12 Cans
- Spot Clean/Air Dry

**#35116 KOOL PAK® 36 CAN COOLER BACKPACK**

- Made Of 420D Polyester
- 12C Gray PEVA Lining With 6MM PE Foam
- Double Zippered Main Compartment
- Front Zippered Pocket
- 2 Side Mesh Pockets
- Adjustable Padded Shoulder Straps And Web Carrying Handle
- Holds Up To 36 Cans
- Spot Clean/Air Dry

**#35117 KOOL PAK® 32 CAN COOLER TOTE BAG**

- Made Of 420D Polyester
- 12C PEVA Gray Lining With 6MM PE Foam
- Zippered Main Compartment
- Front Zippered Pocket
- Web Carrying Handles With Hook And Loop Closure Comfort Grip
- Holds Up To 32 Cans
- Back Trolley Strap
- Spot Clean/Air Dry

# DRINKWARE



#54035



#550075



## #54035 - 40 OZ. KOOL PAK® STAINLESS STEEL TUMBLER

- Stainless Steel Outer And Inner
- Stainless Steel Tumbler With Handle · Powder Coated Finish
- Double Wall Construction For Insulation Of Hot Or Cold Liquids
- Keeps Drinks Cold Up To 24 Hours And Hot Up To 8 Hours
- Screw On, Spill-Resistant Lid with Straw Hole and 12" Straw
- Vacuum Insulated · Meets FDA Requirements
- BPA Free · Hand Wash Recommended



## #550075 - 40 OZ. FULL COLOR JACKSON INTREPID STAINLESS STEEL TUMBLER

- Stainless Steel Outer And Inner
- Stainless Steel Tumbler With Handle · Powder Coated Finish
- Double Wall Construction For Insulation Of Hot Or Cold Liquids
- Keeps Drinks Cold Up To 24 Hours And Hot Up To 8 Hours
- Screw On, Spill-Resistant Lid With Straw Hole And 12" Straw
- Vacuum Insulated · Meets FDA Requirements
- BPA Free · Hand Wash Recommended



## #550078 - 40 OZ. FULL COLOR QUEST RECYCLED STAINLESS STEEL TUMBLER

- Recycled Stainless Steel Outer And Recycled Plastic Inner Liner With Handle
- Powder Coated Finish
- Double Wall Construction For Insulation Of Hot Or Cold Liquids
- Screw On, Spill-Resistant Lid with Straw Hole and 12" Straw
- Meets FDA Requirements
- BPA Free
- Hand Wash Recommended



## #51036 - 30 OZ. INTREPID RECYCLED STAINLESS STEEL TUMBLER

- Recycled Stainless Steel Outer And Inner
- Recycled PP Handle, Slider And Straw
- Recycled AS Lid
- Stainless Steel Tumbler With Handle
- Powder Coated Finish
- Double Wall Construction For Insulation Of Hot Or Cold Liquids
- Screw On, Spill-Resistant Lid With Straw Hole And 12" Straw
- Vacuum Insulated
- Meets FDA Requirements
- BPA Free
- Hand Wash Recommended



#550078



#51036



**#51035 - 30 OZ. INTREPID RECYCLED TUMBLER**

- Recycled Stainless Steel Outer And Recycled Plastic Inner Liner With Handle
- Powder Coated Finish
- Double Wall Construction For Insulation Of Hot Or Cold Liquids
- Screw On, Spill-Resistant Lid With Straw Hole And 12" Straw
- Vacuum Insulated
- Meets FDA Requirements
- BPA Free
- Hand Wash Recommended



**#50098 - 40 OZ. INTREPID RECYCLED AS DOUBLE WALL TUMBLER**

- Recycled AS Outer And Inner
- Recycled AS Lid And Recycled PP Straw
- Double Wall Construction For Insulation Of Hot Or Cold Liquids
- Snap On, Spill-Resistant Lid With Straw Hole And 12" Straw
- Meets FDA Requirements
- BPA Free
- Hand Wash Recommended



**#50164 - 40 OZ. PEAK INTREPID STAINLESS STEEL TUMBLER**

- Stainless Steel Outer And Inner
- Powder Coated Finish
- Double Wall Construction For Insulation Of Hot Or Cold Liquids
- Keeps Drinks Cold Up To 24 Hours And Hot Up To 8 Hours
- Screw On, Spill-Resistant Flip Top Lid Easy Carry Handle
- Vacuum Insulated
- Meets FDA Requirements
- BPA Free
- Hand Wash Recommended



**#99909 - 20 OZ. FULTON STAINLESS STEEL MUG WITH STRAW**

- Kit Includes #50014 - 20 Oz. Fulton Stainless Steel Mug And #5202 Stainless Steel Straw With Cleaning Brush
- Stainless Steel Tumbler With Handle
- Pricing Includes 1 Color/1 Location On #50014 - 20 Oz. Fulton Stainless Steel Mug



#75056



Tumbler not included

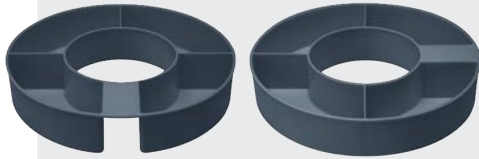

#5276



Tumbler & contents not included



#30132



#55276

**#75056 INTREPID TUMBLER SNACK BOWL**

- Four Compartment Snack Tray Rests On Tumbler Handle
- Compatible With Intrepid Collection 40 Oz. Tumblers With Handles
- Meets FDA Requirements · BPA Free · Hand Wash Recommended

**#30132 INTREPID RPET PHONE POUCH**

- Made Of 230D rPET Twill Polyester
- Fits 40 Oz. Tumbler · Made From Post Consumer Recycled Materials
- Recycled Polyester (rPET) Is Obtained By Melting Down Existing Plastic Bottles And Other Material Sources To Create New Polyester Fiber
- Zipper, Shoulder, Inside Binding, Buckle And Label Are Not rPET
- Zippered Main Compartment
- Adjustable Belt With Hook And Loop Closure And Rubber Grips To Prevent Sliding
- Front Slip Pocket · Can Accommodate Apple® iPhone 14 Pro Max · Spot Clean/Air Dry
- Apple is a trademark of Apple Inc., registered in the U.S. and other countries.

**#5276 STRAW TOPPER FOR 40 OZ. INTREPID TUMBLERS**

- Made Of Silicone
- Compatible With Intrepid Collection 40 Oz. Tumblers
- Reusable
- Hand Wash Recommended

**#55276 INTREPID STRAW TOPPER KIT**

- Set Includes #50035 - 40 Oz. Intrepid Stainless Steel Tumbler and #5276 Straw Topper For 40 Oz. Intrepid Tumblers
- Pricing Includes 1 Color/1 Location Imprint on Each Item.



- #50405 - 15 OZ. MOOD RECYCLED ALUMINUM CUP
- Made Of Recycled Aluminum
  - Cup Changes Color When Ice-Cold Beverages Are Added
  - Meets FDA Requirements
  - BPA Free
  - Hand Wash Recommended



- #50162 - 15 OZ. GLASS AND STAINLESS STEEL MUG
- Stainless Steel Outer And High Borosilicate Glass Inner
  - Powder Coated Finish · Snap-On, Spill-Resistant Thumb-Slide Lid
  - Not For Hot Liquid Use · Meets FDA Requirements
  - BPA Free · Hand Wash Recommended



- #55501 - 20 OZ. THERMO MUG
- Made Of Polypropylene
  - Double-Wall Insulation Keeps Beverages Hot Or Cold
  - Snap-On, Spill-Resistant Drink-Through Swivel Lid With Flexible Corrugated Straw With A Cap To Provide Multiple Drinking Options
  - Features A Wide Handle For Easy Carrying
  - For Coffee, Tea, Hot Chocolate And Any Other Hot Beverages Or Cold Fountain Drinks, Lemonade And Iced Tea
  - Easy To Clean
  - Hand Wash Recommended
  - Meets FDA Requirements
  - BPA Free
  - Made In USA



- #55502 - 32 OZ. THERMO MUG
- Made Of Polypropylene
  - Double-Wall Insulation Keeps Beverages At Temperature
  - Snap-On, Spill-Resistant Drink-Through Swivel Lid With Flexible Corrugated Straw With A Cap To Provide Multiple Drinking Options
  - Features A Wide Handle For Easy Carrying
  - Easy To Clean
  - Hand Wash Recommended
  - Meets FDA Requirements
  - BPA Free
  - Made In USA

#55501

#55502



#50166



#60055

**#50166 - 17 OZ. SODA LIME GLASS CAN WITH BAMBOO LID**

- Made Of Soda Lime Glass
- Perfect For Staff Birthdays, Housewarming Gifts, Graduation, Weddings And More
- Snap-On, Spill-Resistant Bamboo Lid With 8" Straw
- Create A Surprising Presentation For Your Favorite Cocktail Recipes With This Novelty Can Shape Glass
- Not For Hot Liquid Use
- Meets FDA Requirements
- BPA Free
- Hand Wash Recommended

**#60055 - 16 OZ. FULL COLOR CAN GLASS WITH BAMBOO LID**

- Perfect For Staff Birthdays, Housewarming Gifts, Graduation, Weddings And More
- Snap-On, Spill-Resistant Bamboo Lid And 8" Stainless Steel Straw With Rubber Top For Sipping
- Create A Surprising Presentation For Your Favorite Cocktail Recipes With This Novelty Can Shape Glass
- Not For Hot Liquid Use
- Meets FDA Requirements
- BPA Free
- Hand Wash Recommended

**#66016 - 16 OZ. FULL COLOR ALE GLASS CAN**

- Eye-Catching Can Shape Glass
- Meets FDA Requirements
- Hand Wash Recommended

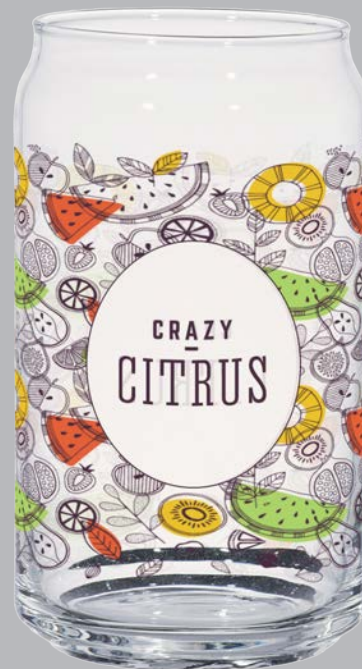

#66016

**MEGA  
BRITE**



- #50240 - 24 OZ. POP SIP RECYCLED STAINLESS STEEL BOTTLE
- Recycled Stainless Steel Outer And Inner
  - Powder Coated Finish
  - Screw On, Spill-Resistant Sip Through Lid
  - Push Button To Pop Lid
  - Easy Carry Handle
  - Meets FDA Requirements
  - BPA Free
  - Hand Wash Recommended



- #50408 - 32 OZ. POP SIP RECYCLED STAINLESS STEEL BOTTLE
- Recycled Stainless Steel Outer And Inner
  - Powder Coated Finish
  - Screw On, Spill-Resistant Sip Through Lid
  - Push Button To Pop Lid Open
  - Easy Carry Handle
  - Meets FDA Requirements
  - BPA Free
  - Hand Wash Recommended



- #50023 - 22 OZ. DARCY ALUMINUM BOTTLE
- Screw On, Spill-Resistant Lid
  - Easy Carry Handle
  - Wide Mouth Opening
  - Lids Packed Separately and Unassembled
  - Meets FDA Requirements
  - BPA Free
  - Hand Wash Recommended



- #50409 - 22 OZ. MEMPHIS RECYCLED ALUMINUM BIKE BOTTLE
- Recycled Aluminum Outer And PP Inner
  - Smooth Rubberized Finish
  - Single Wall Construction
  - Screw On, Spill-Resistant Sip Top Lid
  - Easy Carry Handle
  - Meets FDA Requirements
  - BPA Free
  - Hand Wash Recommended



- #50411 - 25 OZ. BLAIRE RECYCLED ALUMINUM BOTTLE
- Recycled Aluminum Outer And Inner
  - Smooth Rubberized Finish
  - Double Wall Construction For Insulation Of Hot Or Cold Liquids
  - Screw On, Spill-Resistant Lid
  - Wide Mouth Opening
  - Meets FDA Requirements
  - BPA Free
  - Hand Wash Recommended



- #50418 - 17 OZ. HAILEY RECYCLED STAINLESS STEEL BOTTLE
- Recycled Stainless Steel Outer And Inner
  - Double Wall Construction For Insulation Of Hot Or Cold Liquids
  - Screw On, Spill-Resistant Sip Top Lid
  - Powder Coated Finish
  - Tone-On-Tone Look With Matching Lid And Base
  - Easy Carry Handle
  - Meets FDA Requirements
  - BPA Free
  - Hand Wash Recommended



- #50403 - 32 OZ. AUSTIN RECYCLED STAINLESS STEEL BOTTLE
- Stainless Steel Outer And Inner
  - Screw On, Spill-Resistant Flip-Top Lid
  - Powder Coated Finish
  - Meets FDA Requirements
  - BPA Free
  - Hand Wash Recommended



- #50407 - 27 OZ. ELLIS RECYCLED ALUMINUM BOTTLE WITH BAMBOO LID
- Recycled Aluminum Outer And PP Inner
  - Double Wall Construction For Insulation Of Hot Or Cold Liquids
  - Screw On, Spill-Resistant Sip Top Lid
  - Easy Carry Handle
  - Meets FDA Requirements
  - BPA Free
  - Hand Wash Recommended



**MEGA  
BRITE**

#55702 - 25 OZ. FULL COLOR ALUMINUM  
TUNDRA BIKE BOTTLE

- Screw On, Spill-Resistant Lid
- Split Ring Attachment
- Meets FDA Requirements
- BPA Free
- Hand Wash Recommended



#50301 - 17 OZ. DIXON RECYCLED STAINLESS  
STEEL BOTTLE

- Recycled Stainless Steel Inner and Outer
- Powder Coated Finish
- Double Wall Construction For Insulation  
Of Hot Or Cold Liquids
- Screw On, Spill-Resistant Lid
- Dual Wide Mouth Opening
- Top Portion Of Bottle Converts Into A Cup
- Easy Carry Handle · Meets FDA Requirements
- BPA Free · Hand Wash Recommended



**MEGA  
BRITE**

#550042 - 20 OZ. FULL COLOR JACLYN RPET BOTTLE

- Made From Post Consumer Recycled Materials
- rPET Inner And Outer
- Recycled Polyester (rPET) Is Obtained By Melting Down  
Existing Plastic Bottles And Other Material Sources To  
Create New Polyester Fiber
- PP And Stainless Steel Lid
- Lid, O-Ring And Wrist Strap Are Not rPET
- Screw On, Spill-Resistant Lid
- Easy Carry Strap
- Wide Mouth Opening
- Meets FDA Requirements
- BPA Free
- Hand Wash Recommended



#50412 - 20 OZ. MADDIE RPET BOTTLE WITH CORK LID

- Made From Post Consumer Recycled Materials
- rPET Inner And Outer
- Recycled Polyester (rPET) is Obtained By Melting  
Down Existing Plastic Bottles And Other Material  
Sources To Create New Polyester Fiber
- Cork And Silicone Lid
- Lid Is Not rPET
- Press On, Spill-Resistant Lid
- Wide Mouth Opening
- Meets FDA Requirements
- BPA Free
- Hand Wash Recommended

Carabiner Optional



#55702



#50301



#550042



#50412



#50243



#50243 - 32 OZ. KENNY RPET BOTTLE

- rPET Inner And Outer
- Made From Post Consumer Recycled Materials
- Recycled Polyester (rPET) is Obtained By Melting Down Existing Plastic Bottles And Other Material Sources To Create New Polyester Fiber
- Recycled AS Lid
- Lid Is Not rPET · Screw On, Spill-Resistant Lid
- Wide Mouth Opening · Easy Carry Handle
- Meets FDA Requirements · BPA Free
- Hand Wash Recommended



#50401 - 32 OZ. POP SIP RPET BOTTLE

- Made From Post Consumer Recycled Materials
- rPET Inner And Outer
- Recycled Polyester (rPET) is Obtained By Melting Down Existing Plastic Bottles And Other Material Sources To Create New Polyester Fiber · Recycled PP Lid
- Screw On, Spill-Resistant Sip Through Lid
- Push Button To Pop Lid Open
- Easy Carry Handle · Lid Is Not rPET
- Meets FDA Requirements · BPA Free
- Hand Wash Recommended

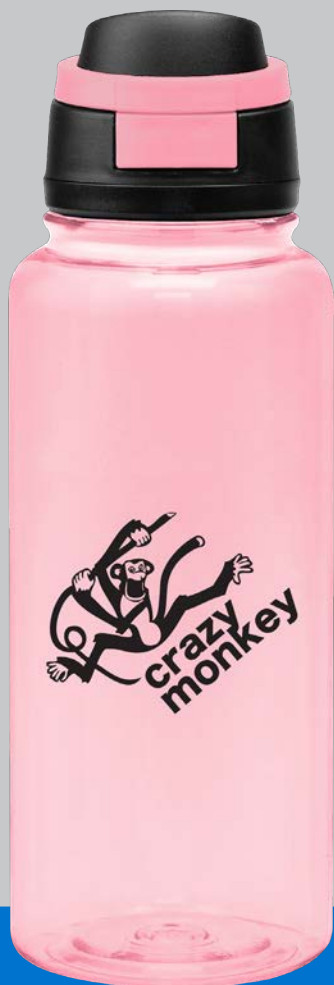

#50401



#50402 - 24 OZ. POP SIP RPET BOTTLE

- Made From Post Consumer Recycled Materials
- rPET Inner And Outer
- Recycled Polyester (rPET) is Obtained By Melting Down Existing Plastic Bottles And Other Material Sources To Create New Polyester Fiber
- Recycled PP Lid
- Screw On, Spill-Resistant Sip Through Lid
- Push Button To Pop Lid Open · Easy Carry Handle
- Lid Is Not rPET · Meets FDA Requirements
- BPA Free · Hand Wash Recommended



#50402



- #60058 - 6 OZ. FULL COLOR WHISKEY GLASS
- Perfect For A Bar Owner, Distillery, Distributor Or Whiskey Enthusiast
  - Use As Party Favors Or To Impress Guests At Your Next Tasting Event
  - Meets FDA Requirements · BPA Free
  - Hand Wash Recommended · Made In USA



- #50415 - 12 OZ. MONTROSE RPET WINE TUMBLER WITH BAMBOO LID
- Made From Post Consumer Recycled Materials
  - Recycled Polyester (rPET) is Obtained By Melting Down Existing Plastic Bottles And Other Material Sources To Create New Polyester Fiber
  - Lid Is Not rPET · Snap On, Spill-Resistant Lid · Meets FDA Requirements
  - BPA Free · Hand Wash Recommended



- #60060 - 12 OZ. FULL COLOR WINE GLASS
- High-Quality Stemware Construction
  - Great Way To Promote Your Bar Or Restaurant
  - Perfect For Corporate Events, Celebrations Or Client Gifts
  - Meets FDA Requirements · BPA Free
  - Hand Wash Recommended · Made In USA



#50070



- #50070 - 34 OZ. CLEAR GLASS CARAFE
- #550070 - 34 OZ. FULL COLOR CLEAR GLASS CARAFE
- 1 Liter Glass Carafe
- Classic Shape With Large Flared Top
- Chip Resistant Rim
- 40 Oz. Rim-Full Capacity
- Decorative And Durable
- Great For Serving Your Favorite Beverage
- Meets FDA Requirements
- BPA Free
- Hand Wash Recommended
- Made In USA



#550070



**MEGA**  
BRITE



#8168 - 12 OZ. MERCER MATTE CERAMIC MUG  
· Meets FDA Requirements  
· Hand Wash Recommended  
· Not Recommended for Commercial Use

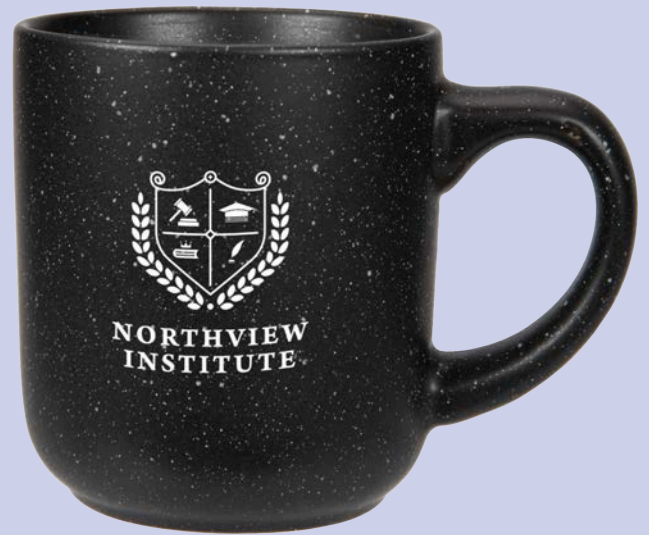

#8195 - 14 OZ. SPECKLED MATTE CERAMIC MUG  
· Meets FDA Requirements  
· Hand Wash Recommended  
· Not Recommended for Commercial Use



#8126 - 18 OZ. PEBBLE GRAIN TEXTURED CERAMIC MUG  
· Meets FDA Requirements  
· Hand Wash Recommended  
· Not Recommended for Commercial Use  
· Mug Finish Will Have Slight Inconsistencies Due To The Special Glaze On Product



#8125 - 12 OZ. DELTON CERAMIC MUG  
· Meets FDA Requirements  
· Hand Wash Recommended  
· Not Recommended for Commercial Use

# HOUSEWARES



#55500 - 64 OZ. BUCKET

- Made Of Polypropylene
- Classic Popcorn Bucket
- Snap-On Lid With Handle For Easy Portability
- For Popcorn, Snacks, Meals Or Other Food Menu Items
- Buckets Nest For Easy Storage
- Meets FDA Requirements
- Easy Clean
- BPA Free
- Made In USA



#75058 RECYCLED SERVING BOWL

- Made Of Recycled Polypropylene
- Meets FDA Requirements
- Hand Wash Recommended



Optional Imprint Area  
Shown For Medium  
And Small Bowls



#75066 BOMBAY BAMBOO NESTING BOWLS

- Set Of 3 Square Bamboo Bowls
- Small, Medium & Large Bowls Nest Neatly For Easy Storage
- Large Bowl - 2 Cup Capacity, Medium Bowl - 1 1/2 Cup Capacity, Small Bowl - 1 Cup Capacity
- Meets FDA Requirements
- Supports Responsible Forestry
- Hand Wash Recommended · FSC® Certified
- FSC® Certified Products Are Made With, Or Contain, Forest-Based Materials Sourced From Forests That Have Been Audited By An Independent Third Party To Confirm They Are Managed According To FSC®'s Rigorous Social And Environmental Standards.



#### #75046 DIGITAL FOOD THERMOMETER

- Food Grade, Stainless Steel Probe With ABS Casing
- Can Withstand Heat Up To 572°F
- Push Button On/Off, Max/Min And Celsius/Fahrenheit
- Replaceable LR44 Button Cell Battery Included
- Digital LCD Display
- Instructions Included
- Easy To Clean
- Hand Wash Recommended



*Spoons Not Included*



#### #75059 BAMBOO SPOON REST

- Made Of Bamboo
- Rest Your Utensils While Cooking To Keep Countertops Neat & Tidy
- Biodegradable · FSC® Certified · Supports Responsible Forestry
- FSC® Certified Products Are Made With, Or Contain, Forest-Based Materials Sourced From Forests That Have Been Audited By An Independent Third Party To Confirm They Are Managed According To FSC's Rigorous Social And Environmental Standards.



#### #75057 BROADVIEW BENTO BOX WITH SPORK

- Lid With Side Clips For A Tight Seal
- Includes Spork
- Spork Stores In Lid For Easy Travel & Storage
- Removable Tray With 3 Compartments To Keep Food Separate And Safe
- Meets FDA Requirements
- BPA Free
- Hand Wash Recommended



#75060 ON THE ROCKS ICE CUBE TRAY

- Made Of Silicone
- Makes 2 Large Square Ice Cubes
- Slower Melting Rate For Whiskey, Bourbon And More
- Infuse Drinks With Fruits And Herbs
- Reusable
- Freeze 3-5 Hours Before Use
- Meets FDA Requirements
- BPA Free
- Hand Wash Recommended



#75062 MINI INTREPID TUMBLER ICE CUBE MOLD

- Made Of Silicone
- Makes 1 Large Ice Cube
- Slower Melting Rate For Whiskey, Bourbon And More
- Infuse Drinks With Fruits And Herbs
- Reusable
- Freeze 3-5 Hours Before Use
- Meets FDA Requirements
- BPA Free
- Hand Wash Recommended



#75064 TIN BOTTLE OPENER MAGNET

- Magnet On Backside







#94086 FULL COLOR 3 PLY PREMIUM COINED BEVERAGE NAPKINS

- Made of Sturdy 3 Ply Paper
- Coined Edges
- Soft Composition That Soaks Up Spills And Stains Easily
- Perfect For Celebrating Anniversaries, Weddings, Birthdays, Graduation Ceremonies And Family Reunions



#94085 FULL COLOR 3 PLY PREMIUM BEVERAGE NAPKINS

- Made of Sturdy 3 Ply Paper
- Uncoined Napkin
- Soft Composition That Soaks Up Spills And Stains Easily
- Perfect For Celebrating Anniversaries, Weddings, Birthdays, Graduation Ceremonies And Family Reunions



#94100 TOASTING WITH TARA™ ROLL OF 50 COCKTAIL NAPKINS

- Made With 100% Disposable Cotton
- Includes 50 Cocktail Napkins Uniquely Packaged Per Roll
- Easy Perforated Seams To Separate Each Piece
- Single Use Or Reusable Up To 3 Times
- Perfect For Celebrating Anniversaries, Weddings, Birthdays, Graduation Ceremonies And Family Reunions
- Bring Style To Your Next Party Or Gathering! · Women Owned
- Elevate The Look With #94101 Toasting With Tara™ Cocktail Napkin Holder (Not Included)
- EQP Does Not Apply



**WOMEN OWNED**



#94101 TOASTING WITH TARA™ COCKTAIL NAPKIN HOLDER

- Made Of Sturdy Stainless Steel Barware
- Elevate The Look Of Any Bar Or Counter
- Makes It Easy To Tear Off A Napkin For Your Next Drink
- Surprise And Delight Your Family And Guests With This Upscale Bar Accessory
- Perfect For Celebrating Anniversaries, Weddings, Birthdays, Graduation Ceremonies And Family Reunions
- Bring Style To Your Next Party Or Gathering!
- Custom Created To Store And Display #94100 Toasting With Tara™ Roll Of 50 Cocktail Napkins (Not Included)
- Women Owned · Sold As Shown · EQP Does Not Apply



#75072



#75073  
Optional Rainbow Holographic Design Shown



#75077



#75072 ACRYLIC COASTER - CIRCLE  
 · Features Full Color Edge-To-Edge Graphics  
 · Made In USA

#75073 ACRYLIC COASTER - SQUARE  
 · Features Full Color Edge-To-Edge Graphics  
 · Made In USA

#75077 ACRYLIC COASTER - CUSTOM SHAPES  
 · Create Your Own Custom Shaped Coaster  
 · Features Full Color Edge-To-Edge Graphics  
 · Made In USA

#75049



#75049 AROMATIC REED DIFFUSER WITH BAMBOO LID  
· 1.1 Oz Lavender Scented Oil In Glass Vessel With Bamboo Lid  
· 5 Natural Reed Sticks Absorb The Oil And Release Scent Into The Air



#85018



#85018 BAMBOO TEA LIGHT CANDLE HOLDER WITH CANDLE  
· Reusable Tea Light Candle Holder Made Of Bamboo  
· Unscented Soy Wax Tea Light Candle Included · Single Wick  
· Non-Toxic And Burns Cleaner Than Paraffin With No Petrol-Carbon Soot  
· Longer Burning And More Efficient Than Paraffin

#75053 ROTATING LIGHT-UP HUMIDIFIER  
· 195 mL Capacity  
· Multi-Color Light Display  
· 330° Rotation  
· Push Buttons To Change Water Vapor And Light Settings  
· Features A Micro-USB Input (Cord Included)





**#75052 MINI GARDEN TOOL SET**

- Set Includes Mini Trowel, Transplanter And Cultivator
- Includes Felt Pouch With Elastic Loops And Hook & Loop Closure For Easy Storage
- Tools Made Of Stainless Steel & Iron With Eucalyptus Wood Handles



**#30121 LEATHERETTE CATCHALL TRAY**

- Made Of 2MM Polyurethane
- Copper Snap Closures
- Spot Clean/Air Dry



**#75061 RECHARGEABLE HANDHELD VACUUM**

- Portable Vacuum Includes Brush Attachment And Wand Attachment For Hard To Reach Areas
- Folds Down To Compact Size For Easy Storage And Travel
- Ideal For Home, Office & Auto Use · Replaceable Dust Bin Filter
- Push Button To Turn On/Off · LED Indicator Lights
- 1200 mAh Lithium Ion Grade A Battery Included
- Features A Type-C Input (Cord Included)
- Charging Time Approximately 3 Hours
- Instructions Included · Not For Use While Charging

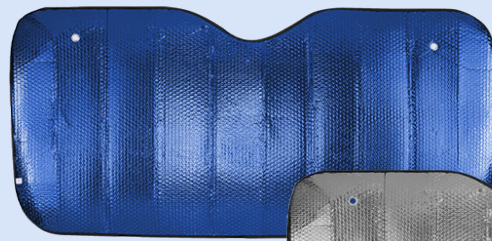

Front

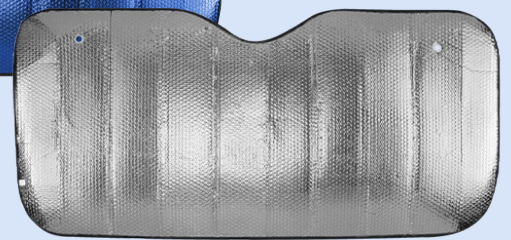

Back



**#75076 ACCORDION AUTO SUN SHADE**

- Made Of 170T Polyester
- Includes Zippered Pouch For Convenient Storage
- Fits Most Windshields
- Spot Clean/Air Dry
- Matching Carrying Case



#75068  
Optional Full Bleed Digibrite Shown

**#75081 - 3-IN-1 CUP LID CLEANING BRUSH SET**

- Includes Bottle Brush, U-Shaped Silicone Cupping Brush And Stiff Bristle Corner Brush
- Manually Rotate From Bottle Brush To Corner Brush
- U-Shaped Silicone Cupping Brush Cleans Stubborn Stains Around Rim Of Cup

**#75068 ALL-IN-ONE SPRAY CLEANER & CLOTH**

- Brushed Cloth Cleans Multiple Surfaces Without Scratching
- Refillable 40 mL Spray Bottle Easily Slides In & Out Of Brush Handle
- Ideal For Home, Office & Auto Use

**#95230 WOOL DRYER BALL SET**

- Includes 3 Reusable Wool Dryer Balls In Drawstring Pouch
- Softens Fabrics And Reduces Drying Time & Static Cling
- Sustainable Alternative To Single Use Dryer Sheets



#75081



#95230

# LEISURE



#6065



## #6065 FAIRWAY FRESH WAFFLE TOWEL

- 100% Recycled Polyester
- Carabiner Attachment (Not Recycled)
- Made From Post Consumer Recycled Materials
- Recycled Polyester (rPET) is Obtained By Melting Down Existing Plastic Bottles And Other Material Sources To Create New Polyester Fiber
- Quick-Absorbing And Quick-Drying

## #7272 TEE TIME GOLF KIT

- Includes 1 Ball Marker, 1 Divot Repair Tool And 4 Wooden Golf Tees
- Zippered Faux Neoprene Pouch With Carabiner Attachment



#7272





- #6061 YOGA MAT SLAP STRAP
- Made Of Silicone & Steel
  - Keeps Yoga Mat Rolled For Easy Travel & Storage
  - Slap Strap Onto Mat To Secure
  - Eliminates The Use Of Loose Straps
  - Fits Most Standard Size Yoga Mats
  - Yoga Mat Sold Separately



Yoga Mat Not Included



- #40004 PICKLEBALL PADDLE COVER
- Made Of 3MM Neoprene
  - Fits Standard Size Pickleball Paddles
  - Zippered Closure
  - Spot Clean/Air Dry



Paddle Not Included



#11010  
Can Not Included



#11011  
Bottle Not Included



#50404

**#11010 KAN-TASTIC SWEATER SLEEVE**

- Made From Ocean Bound Plastic And Spandex
- Fits A Variety Of Sizes Of Cans, Cups And Containers
- Protects Hands From Hot Or Cold Drinks And Condensation
- Folds Flat For Pocket Or Purse Storage

**#11011 KAN-TASTIC TALL SWEATER SLEEVE**

- Made From Ocean Bound Plastic And Spandex
- Fits A Variety Of Sizes Of Bottles, Cans And Tumblers
- Protects Hands From Hot Or Cold Drinks And Condensation
- Folds Flat For Pocket Or Purse Storage

**#50404 - 12 OZ. 4-IN-1 DOUBLE WALLED CAN COOLER**

- Stainless Steel Outer And Inner · Powder Coated Finish
- Functions As A Tumbler, Standard Can Cooler, Slim Can Cooler Or Bottle Cooler · Vacuum Insulated Sweat-Proof Design
- Double Wall Construction For Insulation Of Hot Or Cold Beverages
- Includes Screw On, Spill-Resistant Flip-Top Lid With Easy Carry Handle And Interchangeable Cooler Rim
- Fits Most 12 Oz. Cans, Standard Bottles And Automotive Drink Holders
- Replace The Cooler Rim With The Flip-Top Lid To Use As A 12 Oz. Tumbler
- Meets FDA Requirements · BPA Free · Hand Wash Recommended





#6298 GATSBY RECYCLED FRAME SUNGLASSES

- Frames And Temples Are Made Of rABS
- UV400 Lenses Provide 100% UVA And UVB Protection
- Recycled ABS (Acrylonitrile Butadiene Styrene) Is Obtained By Melting Down Post Consumer ABS Plastic To Create New ABS Plastic



#8246 SWIFT AVIATOR SUNGLASSES

- UV400 Lenses Provide 100% UVA And UVB Protection



#8245 AVIATOR SUNGLASSES WITH MIRRORED LENSES

- UV400 Lenses Provide 100% UVA And UVB Protection
- Mirrored Lenses



#### #8297 JAGGER RECYCLED FRAME SUNGLASSES

- Frames Are Made Of rBAS
- Recycled ABS (Acrylonitrile Butadiene Styrene) Is Obtained By Melting Down Post Consumer ABS Plastic To Create New ABS Plastic.
- UV400 Lenses Provide 100% UVA And UVB Protection



#### #8221 RAVI RECYCLED FRAME SUNGLASSES

- Frames And Temples Are Made Of rABS
- UV400 Lenses Provide 100% UVA And UVB Protection
- Recycled ABS (Acrylonitrile Butadiene Styrene) Is Obtained By Melting Down Post Consumer ABS Plastic To Create New ABS Plastic



#### #8225 ZANDER RECYCLED FRAME SUNGLASSES

- Frames And Temples Are Made Of rABS
- UV400 Lenses Provide 100% UVA And UVB Protection
- Recycled ABS (Acrylonitrile Butadiene Styrene) Is Obtained By Melting Down Post Consumer ABS Plastic To Create New ABS Plastic.





#7075

Optional Bag Imprint



**#7075 RPET FOLDING CHAIR WITH CARRYING BAG**

- Made Of 600D rPET With PE Coating
- Made From Post Consumer Recycled Materials
- Recycled Polyester (rPET) is Obtained By Melting Down Existing Plastic Bottles And Other Material Sources To Create New Polyester Fiber
- Drawstring Carrying Bag With Shoulder Strap
- Powder-Coated Steel Tubular Frame - Weight Limit 250 Lbs.
- Label, Plastic & Metal Parts Are Not rPET

**#70020 PORTABLE RECLINING STADIUM CHAIR**

- Made Of 600D Polyester With Padded Foam, Steel Tube And PVC Grid Backing
- Reclines Into Padded Stadium Chair With Arm Rests
- Anchor Strap With Buckle Closure Secures Chair To Bleacher
- Collapses Flat For Easy Travel & Storage
- Adjustable Backpack-Style Shoulder Straps
- Removable Side Pouch With 2 Slip Pockets And 2 Zippered Pockets



#70020



**#35121 COLLAPSIBLE PICNIC BASKET COOLER**

- Made Of Combo: Polypropylene, Chrome Plated Iron And TPE
- 16L Capacity · Collapsible/Expandable Bucket
- Features Foldable Handles · Durable Lid With Clips For A Tight Seal
- Lid Can Be Used As A Cutting Board
- Brackets On Underside Of Lid Can Be Folded Out To Create A Small Table
- 2 Locking Clips · 2 Placements For Cups
- Mobile Slot In Lid Holds A Variety Of Phone Or Tablet Sizes For Easy Viewing
- Silicone Bottom Can Pop Out And Be Used For Ice And Drinks
- Collapsible For Easy Storage · Spot Clean/Air Dry

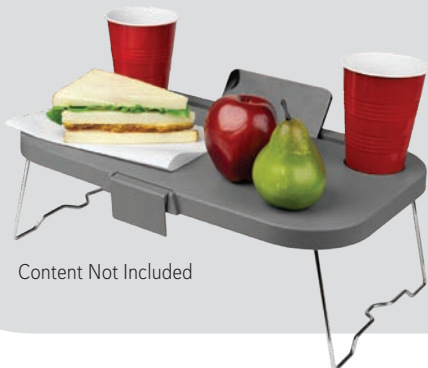

Content Not Included



#35121

**#55242 BEND & SNAP RECHARGEABLE FAN**

- Use As A Handheld Fan Or Bend Arm To Prop Up
- 4 Adjustable Speeds Provide 2 1/2 To 15 Hours Of Wind
- Push Button To Turn On/Off And Change Settings
- Wrist Strap For Carrying
- Digital Power Level Indicator
- Features A Type-C Input (Cord Included)
- 1800 mAh Rechargeable Battery Included



#55242



TYPE-C

**#26557 RECHARGEABLE POWER BANK WITH FAN & FLASHLIGHT**

- Fold Out Fan Can Be Used On Desktop Or Handheld
- 2 Fan Speeds
- Bright White LED Flashlight
- Press Button to Turn On/Off
- Carabiner Attachment
- Indicator Lights
- 1800 mAh Lithium Ion Grade A Non-Recycled Battery
- Output: 5W
- Features Type-C Input (Cord Included)
- Charges Most Devices
- Charge Multiple Devices At Once When Using An Ample Power Source
- Requires Your Phone's Charging Cord To Charge Your Device



#26557



**#10205 - 15" X 18" RECYCLED POLY RALLY TOWEL**

- 250 GSM 100% rPET
- Made From Post Consumer Recycled Materials
- Recycled Polyester (rPET) Is Obtained By Melting Down Existing Plastic Bottles And Other Material Sources To Create New Polyester Fiber
- Features Edge-To-Edge Full Color Imprint
- Solid Color Backing
- Great For The Beach, Boating Or Any Outdoor Water Activity
- Show Your Team Spirit With Colorful Rally Towels!
- Great Promotional Product For Giveaways, Promotions, Or Just For Fun
- This Material Is Recyclable In Limited Facilities In The US. Consumers Should Check Their Local Recycling Capacities Before Placing In Their Recycling Bins.



#10205



#8091  
Towels Not Included



#8091 CHAIR BAND TOWEL HOLDER  
 · Made Of Polyester & Rubber  
 · Stretch Over Chair To Secure Towel, Swimsuit, Etc.



#98090 TOWEL CHAIR CLIP SET  
 · Firmly Attaches Towel To Chair Or Lounger  
 · Set Includes 2 #8090 Towel Chair Clips  
 · Price Includes 1-Color Imprint On Each Clip

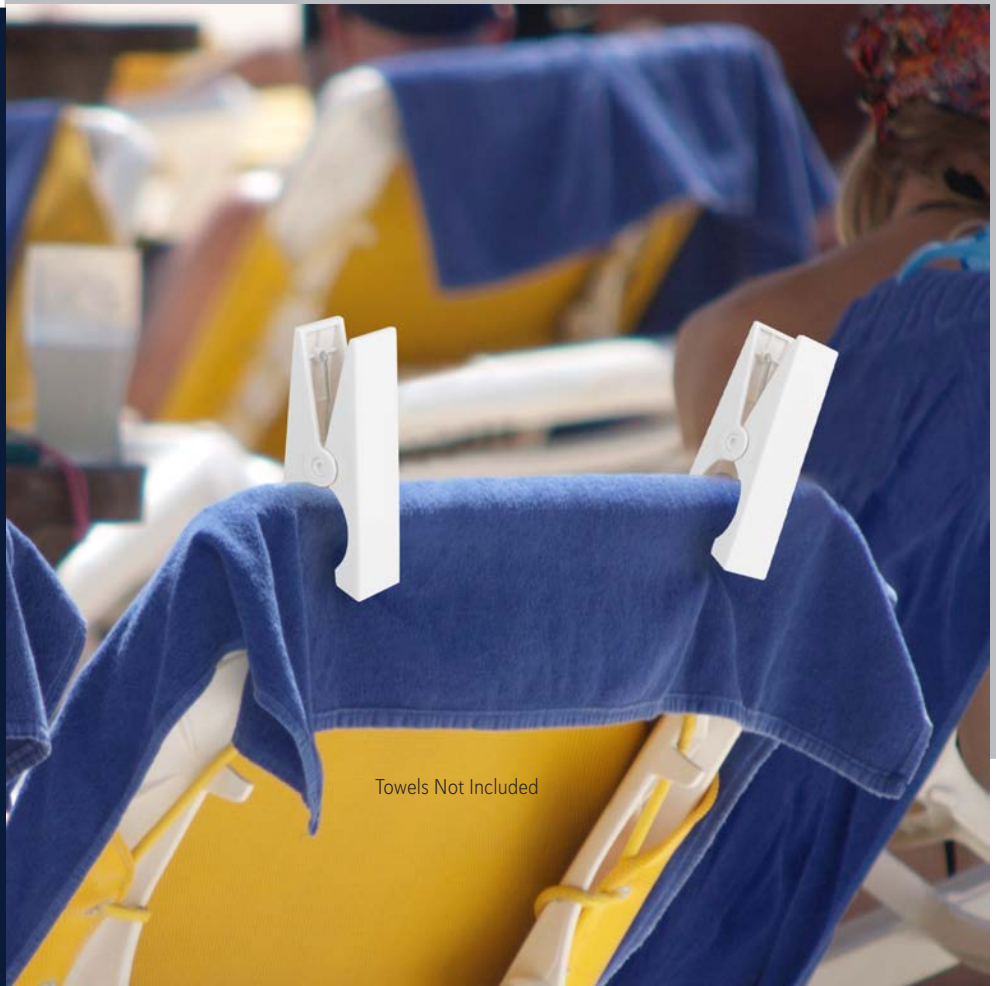

Towels Not Included



#10206

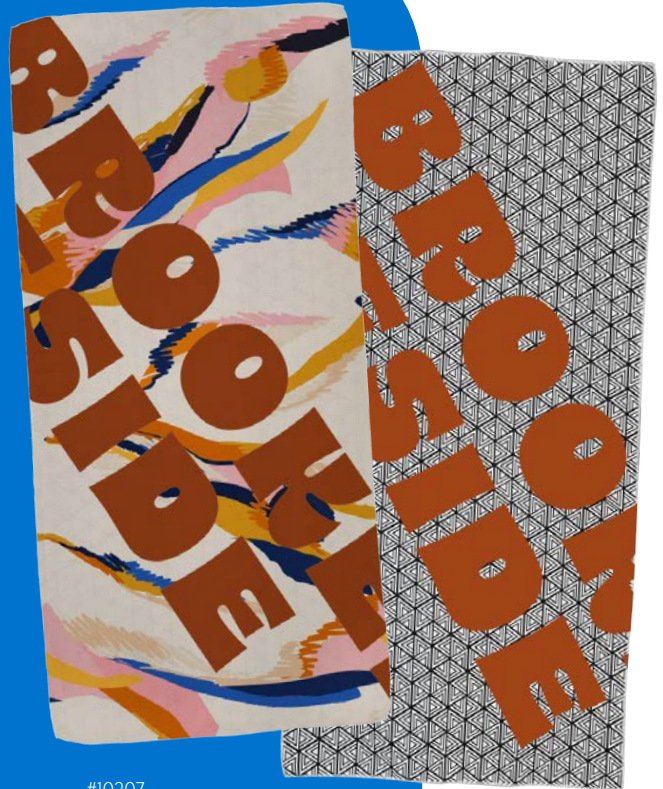

#10207



#10209

- #10206 - 30" X 60" SAND-FREE WAFFLE BEACH TOWEL
- 380 GSM 100% Polyester
  - Absorbent, Super-Compact And Quick Drying
  - Sand-Free Design Made To Keep Sand Off
  - Features Edge-To-Edge Full Color Imprint
  - Great For The Beach, Boating Or Any Outdoor Water Activity



- #10207 - 30" X 60" SAND-FREE WAFFLE BEACH TOWEL
- 380 GSM 100% rPET
  - Made From Post Consumer Recycled Materials
  - Recycled Polyester (rPET) Is Obtained By Melting Down Existing Plastic Bottles And Other Material Sources To Create New Polyester Fiber
  - Absorbent, Super-Compact And Quick Drying
  - Sand-Free Design Made To Keep Sand Off
  - Features Edge-To-Edge Full Color Imprint
  - Geometric Print Backing Enhances The Look Of Your Towel
  - Great For The Beach, Boating Or Any Outdoor Water Activity
  - This Material Is Recyclable In Limited Facilities In The US. Consumers Should Check Their Local Recycling Capacities Before Placing In Their Recycling Bins.

- #10209 - 30" X 60" VELOUR BEACH TOWEL
- 500 GSM 52% Polyester and 48% Cotton
  - Premium Super Plush Beach Towel
  - Terry Cotton Loop Backing For Great Absorbency
  - Features Edge-To-Edge Full Color Imprint
  - Great For The Beach, Boating Or Any Outdoor Water Activity
  - 15.5# Lbs Dozen



#8070



#8071



#8072



**#8070 ALPINE RPET SHERPA BLANKET**

- Large 48" x 63" rPET 280 GSM Sherpa Fleece
- Made From Post Consumer Recycled Materials
- Recycled Polyester (rPET) is Obtained By Melting Down Existing Plastic Bottles And Other Material Sources To Create New Polyester Fiber
- Super Soft Feel
- Cable Knit Design
- Surface Washable

**· #8071 BUFFALO CHECK THROW BLANKET**

- Large 50" x 60" 100% Polyester
- Soft & Lightweight
- Surface Washable

**#8072 SOUTHAMPTON THROW BLANKET**

- Large 53" x 67" 100% Acrylic With Whipstitch
- Warm & Cozy Throw With Reverse Pattern On Each Side
- Surface Washable



- #10208 - 30" X 40" SILK TOUCH SHERPA BLANKET
- 100% Polyester
  - Super Plush Blanket Combining Silk Touch
  - Silk Touch Front And A High Profile Faux Sherpa On The Back Side
  - Features Edge-To-Edge Full Color Imprint

#10208



#8073 RPET FOLDAWAY BLANKET

- Large 50" x 60" Recycled 190T Quilted Polyester Taffeta
- Folds Into Self-Contained Carrying Bag With Zippered Closure, Front Slip Pocket And Adjustable Shoulder Strap
- Water-Resistant
- Ideal For Outdoor Use
- Made From Post Consumer Recycled Materials
- Recycled Polyester (rPET) is Obtained By Melting Down Existing Plastic Bottles And Other Material Sources To Create New Polyester Fiber
- Shoulder Strap & Zipper Are Not rPET
- Surface Washable

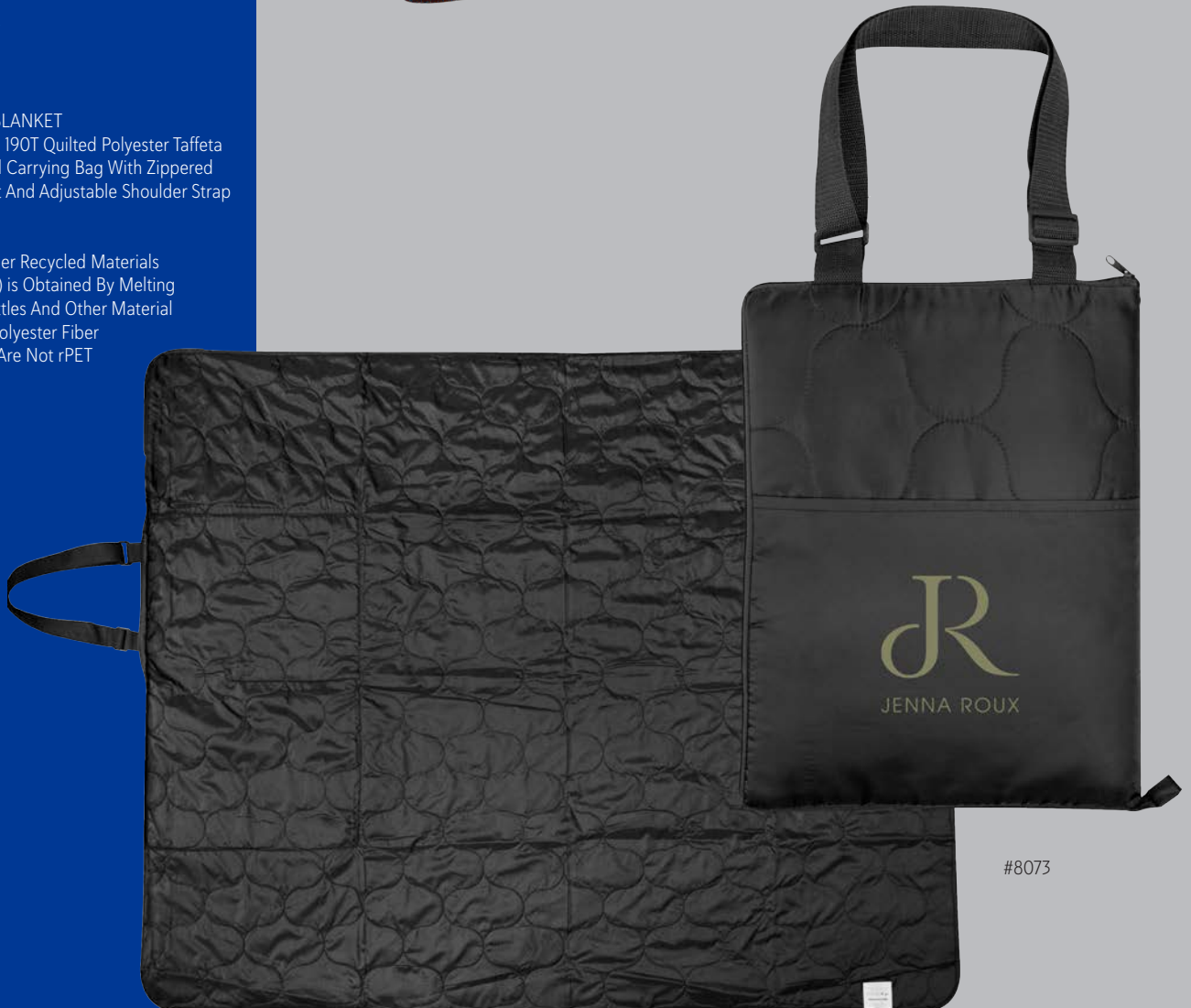

#8073





**#45012 - 70" ARC BEACH UMBRELLA**

- Manual Open & Manual Close
- 170T Polyester
- Metal Shaft With White Coating And White Steel Ribs
- Extends To 68" High
- Features A Pointed Tip For Easy Beach Set Up
- Includes Matching Carrying Sleeve With Strap
- 38 1/2" Closed



**#45005 - 46" ARC UMBRELLA WITH 100% RPET CANOPY & BAMBOO HANDLE**

- Made From Post Consumer Recycled Materials
- Recycled Polyester (rPET) is Obtained By Melting Down Existing Plastic Bottles And Other Material Sources To Create New Polyester Fiber
- Frame And Handle Are Not rPET · Manual Open
- Steel Frame · Bamboo Handle · 34" Closed



**#45010 - 46" ARC UMBRELLA WITH PROP STAND**

- Prop Against Any Surface Or Hang From A Hook For Convenient Storage
- Auto Open & Manual Close · Metal Ribs & Shaft
- 190T Pongee Material · Rubberized Handle For Comfortable Grip
- 31" Closed



**#45013 - 47" ARC EXTENDED COVERAGE UMBRELLA**

- Features Extended Panel In Contrasting Accent Color
- Auto Open & Manual Close
- 210D Polyester With UV Coating (Not Included On Extended Panel)
- Fiberglass Frame · Hook & Loop Closure · 33 1/2" Closed



#45009

#45009 - 46" ARC REFLECTIVE UMBRELLA WITH CARABINER HANDLE

- Auto Open, Manual Close
- Metal and Glass Fiber Frame And Shaft
- Carabiner Handle
- Black Underside With UV Protection
- Pongee Material With Reflective Trim
- 16 1/2" Closed



#45002

#45002 - 58" ARC HAAS-JORDAN™ MAELSTROM UMBRELLA

- Automatic Open
- Wind-Vented Canopy
- Lightweight Metal Frame
- Polyester Canopy And Matching Umbrella Sleeve With Shoulder Strap
- Braided Wrist Strap

#45003 - 62" ARC HAAS-JORDAN™ PRO-LINE UMBRELLA

- Push Button Manual Open
- Lightweight Fiberglass Frame
- Polyester Canopy And Matching Umbrella Sleeve
- Pro-Grip Handle



#45003





- #7755 PEVA PONCHO WITH DRAWSTRING POUCH
- Hooded Poncho Made Of PEVA
  - Drawstring Pouch With Mesh And Front Slip Pocket
  - One Size Fits All
  - Great For Outdoor Events

Phone Not Included

#7756 PE PONCHO WITH RPET POUCH

- Hooded Poncho Made Of PE
- rPET Drawstring Pouch
- Pouch Made From Post Consumer Recycled Materials
- Recycled Polyester (rPET) is Obtained By Melting Down Existing Plastic Bottles And Other Material Sources To Create New Polyester
- Cord Lock And Drawstring Are Not rPET
- One Size Fits All
- Great For Outdoor Events





#9755 FIRST CLASS BAMBOO & SILICONE LUGGAGE TAG

- Silicone Holder With Bamboo ID Card
- Personal Information Is Concealed, Only Your Name Is Visible
- Silicone Loop Attaches Securely To Luggage, Backpacks, Laptop Cases, Etc.

#9756 RECYCLED LEATHERETTE LUGGAGE TAG

- Recycled Polyurethane Material
- Clear Window With ID Card (Not Recycled)
- Adjustable Strap With Buckle Closure



#9755

#9756



- #75200 ACRYLIC BAG TAG
- #75201 ACRYLIC BAG TAG - 4" SQUARE
- #75202 ACRYLIC BAG TAG - CIRCLE
- #75203 ACRYLIC BAG TAG - RECTANGLE
- #75204 ACRYLIC BAG TAG - CUSTOM SHAPES 9"
- #75205 ACRYLIC BAG TAG - CUSTOM SHAPES 6"
- #75206 ACRYLIC BAG TAG - CUSTOM SHAPES 5"
- #75207 ACRYLIC BAG TAG - CUSTOM SHAPES 4"

- Features Full Color Edge-To-Edge Graphics
- Durable PVC Spaghetti Strap Attachment
- Made In USA
- Optional Glitter Or Rainbow Holographic Design

#75200



#75201



Optional Rainbow Holographic Design Shown

#75202



Optional Rainbow Holographic Design Shown

#75203



#75204



Optional Glitter Design Shown

#75205



#75206



Optional Glitter Design Shown

#75207



Optional Rainbow Holographic Design Shown

# PLUSH & NOVELTIES

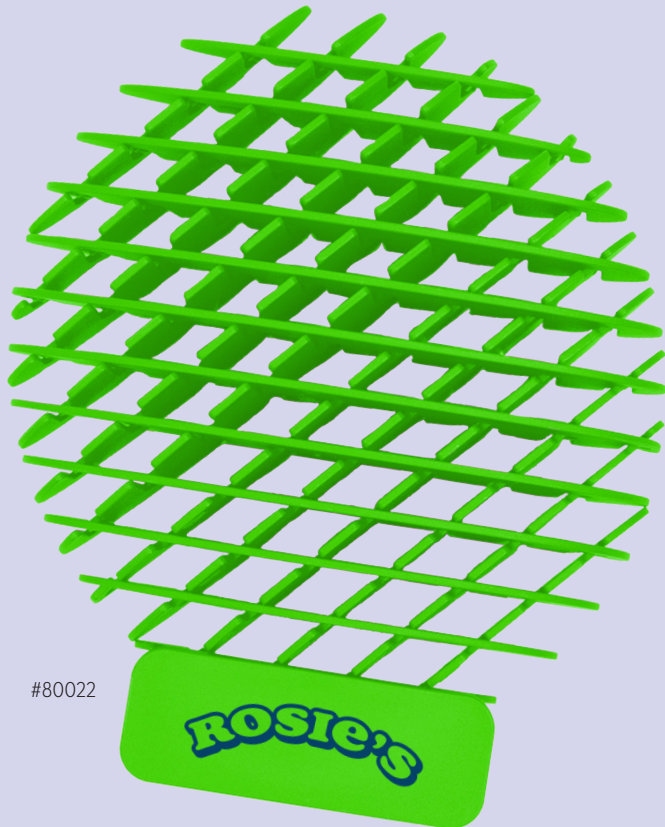

#80022



#80018



#80023



## #80023 PUSH POP CUBE FIDGET TOY

- Made Of Silicone · Press Bubbles Down To Relieve Stress
- Make Your Own Pattern By Pressing On Different Bubbles Or Just Press For Fun
- Provides Tactile Stimulation
- Perfect For Reducing Stress And Boredom
- Encourages Focus And Self-Soothing For Users With Anxiety, Attention Disorders And More
- Fun For All Ages 3+

## #80022 FIDGET SENSORY WORM

- Made Of Flexible Plastic
- Squeeze, Stretch And Twist For Tactile Stimulation
- Perfect For Reducing Stress And Boredom
- Encourages Focus And Self-Soothing For Users With Anxiety, Attention Disorders And More
- Fun For All Ages 3+

## #80018 NEON STRESS BALL RELIEVER

- Made Of Polyurethane Foam
- Returns To Original Shape After Squeezing
- Squeeze Your Tensions Away!



#80025



#80026

Back

**#80025 PET ROPE DISC TOY**

- Made With 420D Polyester And Cotton Rope
- Fun For Playing Fetch, Tug-Of-War Or As A Chew Toy

**#80026 SLOW FEEDER PET LICK FOOD MAT**

- Food Grade Silicone Material
- Textured Surface Encourages Slower Eating And Provides Mental Stimulation
- Suitable For Wet Or Dry Food
- Suction Grips On Bottom For Stability
- Carabiner Attachment · Easy To Clean



**MEGA BRITE** **MADE IN THE USA**

- #80037 ACRYLIC CHARM WITH CHAIN - STAR
- Features Full Color Edge-To-Edge Graphics
  - Includes 24" Ball Chain
  - Made In USA



**MEGA BRITE** **MADE IN THE USA**

- #80038 ACRYLIC CHARM WITH CHAIN - RECTANGLE
- Features Full Color Edge-To-Edge Graphics
  - Includes 24" Ball Chain
  - Made In USA



**MEGA BRITE** **MADE IN THE USA**

- #80040 ACRYLIC CHARM WITH CHAIN - CIRCLE
- Features Full Color Edge-To-Edge Graphics
  - Includes 24" Ball Chain
  - Made In USA



**MEGA BRITE** **MADE IN THE USA**

- #80041 ACRYLIC CHARM WITH CHAIN - SQUARE
- Features Full Color Edge-To-Edge Graphics
  - Includes 24" Ball Chain
  - Made In USA



**MEGA BRITE** **MADE IN THE USA**

- #80042 ACRYLIC DOG TAG WITH CHAIN
- Features Full Color Edge-To-Edge Graphics
  - Includes 24" Ball Chain
  - Made In USA

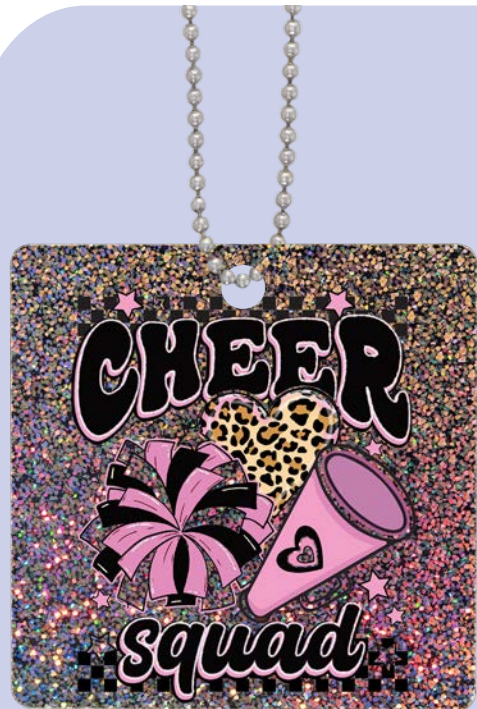

Optional Glitter Design Shown

**MEGA BRITE** **MADE IN THE USA**

- #80039 ACRYLIC CHARM WITH CHAIN - CUSTOM SHAPE 4"
- Create Your Own Acrylic Charm Shape
  - Features Full Color Edge-To-Edge Graphics
  - Includes 24" Ball Chain
  - Made In USA





#7906



#7906 GLOW-IN-THE-DARK SILICONE BRACELET

- Wristband Made Out Of Silicone That Glows In The Dark
- Latex Free
- Perfect To Promote Your Brand Name And Your Organization's Cause
- One Size Fits Most

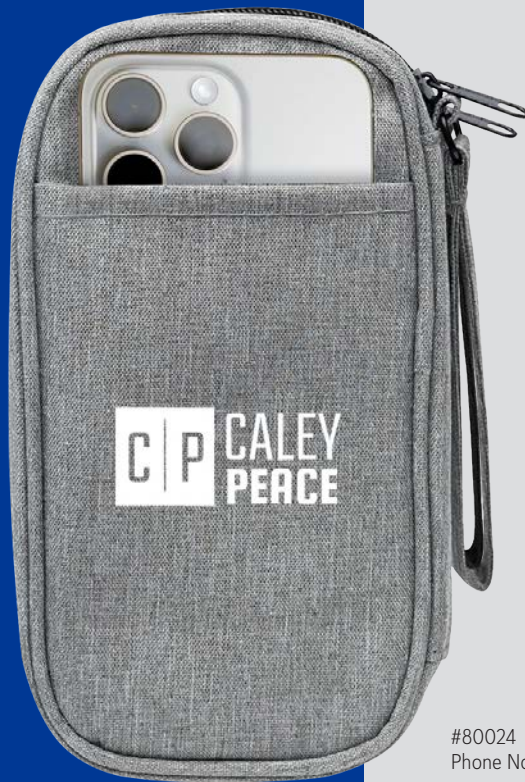

#80024  
Phone Not Included

#80024 TANDEM TECH TRAVEL ORGANIZER

- Made Of Heathered 300D With 190T Lining
- Front Slip Pocket Holds A Variety Of Phone Sizes Up To iPhone® Plus Max
- 2 Zippered Compartments
- Multiple Interior Pockets For Organization
- Wrist Strap
- Spot Clean/Air Dry
- iPhone is a trademark of Apple Inc., registered in the U.S. and other countries.



#80019

#80019 RFID NECK WALLET

- Made Of Combo: 210D Ripstop Nylon And 210D Nylon
- RFID Fabric On Front & Back Panels
- Prevents Data Transfer Between The Wallet And Reader
- Works With Any Contactless Chip Card. Cards That Are Swiped Do Not Send RFID Signals And Will Not Be Protected By An RFID Blocker
- Main Compartment With Hook And Loop Closure · Front Window Pocket
- Adjustable Lanyard With Cord Lock



Contents Not Included

#9215 - 3" X 3" ROUNDED CORNER STICKER

- Square Sticker With Rounded Corners For Indoor Use
- Individually Cut
- Strong Adhesive Sticks To Most Surfaces
- Durable And Moisture Resistant
- Non-Toxic
- Contains No Vinyl Or PVC

#9210 STICKER SHEET 5.5" X 7" STOCK SHAPES

- Customizable Kiss-Cut Sticker Sheet
- Choose From Stock Sticker Shapes - Circle, Oval, Rectangle Or Square
- Permanent Stickers For Indoor Use
- Contains No Vinyl Or PVC
- Excluded From EQP

#9208 ULTRA REMOVABLE STICKER SHEET 5.5" X 7" STOCK SHAPES

- Customizable Kiss-Cut Sticker Sheet
- Choose From Stock Sticker Shapes - Circle, Oval, Rectangle Or Square
- Removable Stickers For Indoor Use
- Contains No Vinyl Or PVC
- Excluded From EQP

#9197 STICKER SHEET 11.5" X 7" STOCK SHAPES

- Customizable Kiss-Cut Sticker Sheet
- Choose From Stock Sticker Shapes - Circle, Oval, Rectangle Or Square
- Permanent Stickers For Indoor Use
- Contains No Vinyl Or PVC
- Excluded From EQP

#9201 ULTRA REMOVABLE STICKER SHEET 11.5" X 7" STOCK SHAPES

- Customizable Kiss-Cut Sticker Sheet
- Choose From Stock Sticker Shapes - Circle, Oval, Rectangle Or Square
- Removable Stickers For Indoor Use
- Contains No Vinyl Or PVC
- Excluded From EQP



#9215



Squares



Rectangles



Circles



Ovals

#9210  
#9208

#9197  
#9201

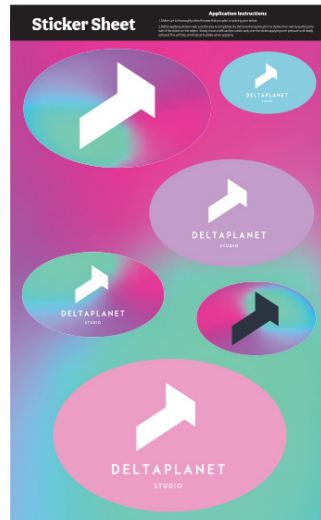

#9209 ULTRA REMOVABLE STICKER SHEET 5.5" X 7" CUSTOM SHAPES

- Fully Customizable Kiss-Cut Sticker Sheet
- Create Your Own Assortment Of Sticker Shapes
- Removable Stickers For Indoor Use
- Contains No Vinyl Or PVC
- Excluded From EQP

#9213 STICKER SHEET 5.5" X 7" CUSTOM SHAPES

- Fully Customizable Kiss-Cut Sticker Sheet
- Create Your Own Assortment Of Sticker Shapes
- Permanent Stickers For Indoor Use
- Contains No Vinyl Or PVC
- Excluded From EQP



#9209 or #9213



#9196 or #9198

#9196 ULTRA REMOVABLE STICKER SHEET 11.5" X 7" CUSTOM SHAPES

- Fully Customizable Kiss-Cut Sticker Sheet
- Create Your Own Assortment Of Sticker Shapes
- Removable Stickers For Indoor Use
- Contains No Vinyl Or PVC
- Excluded From EQP

#9198 STICKER SHEET 11.5" X 7" CUSTOM SHAPES

- Fully Customizable Kiss-Cut Sticker Sheet
- Create Your Own Assortment Of Sticker Shapes
- Permanent Stickers For Indoor Use
- Contains No Vinyl Or PVC
- Excluded From EQP



#1940

#1939  
Optional Rainbow  
Holographic Design Shown

**MEGA BRITE** **MADE IN THE USA**

- #1940 ACRYLIC ORNAMENT - CIRCLE
- Features Full Color Edge-To-Edge Graphics
  - Optional Glitter Or Rainbow Holographic
  - Includes String For Hanging
  - Great For Holiday Giveaways · Made In USA
  - Stock design shown: Gold Flakes

- #1939 ACRYLIC ORNAMENT - TREE
- Features Full Color Edge-To-Edge Graphics
  - Optional Holographic Design Available
  - Includes String For Hanging
  - Great For Holiday Giveaways · Made In USA

- #1942 ACRYLIC ORNAMENT - STAR
- Features Full Color Edge-To-Edge Graphics
  - Optional Glitter Or Rainbow Holographic
  - Includes String For Hanging
  - Great For Holiday Giveaways · Made In USA
  - Stock Design Shown: Happy Holidays 21 And Ugly Sweater 3

- #1941 ACRYLIC ORNAMENT - BELL
- Features Full Color Edge-To-Edge Graphics
  - Optional Glitter Or Rainbow Holographic
  - Includes String For Hanging
  - Great For Holiday Giveaways · Made In USA



#1942

#1941



#1933



- #1933 CHROME ROUND DISK ORNAMENT
- Made Of Polystyrene
  - Includes String For Hanging
  - Great For Holiday Giveaways

- #1943 ACRYLIC ORNAMENT - CUSTOM SHAPES
- Create Your Own Acrylic Ornament Shape
  - Features Full Color Edge-To-Edge Graphics
  - Optional Glitter Or Rainbow Holographic
  - Includes String For Hanging
  - Great For Holiday Giveaways
  - Made In USA

**MEGA BRITE** **MADE IN THE USA**



#1943

Optional Holographic Design

# AMENITIES

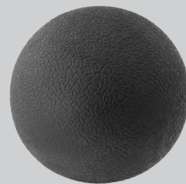

#7870



Standard Imprint Area



Optional Imprint Area

#85014

## #7870 MASSAGE BALL SET

- Set Includes 1 Spiky Ball And 1 Smooth Ball In A Polyester Drawstring Pouch
- Spiky Ball Provides A Deeper Massage While The Smooth Ball Offers A Gentler Massage
- Suitable For Overall Muscle Relaxation And Soothing Tension



## #85014 HANDHELD MASSAGE GUN

- One Setting
- Press On/Off
- Includes rPET Pouch
- Mesh In Pouch Is Made From Post Consumer Recycled Materials
- Recycled Polyester (rPET) is Obtained By Melting Down Existing Plastic Bottles And Other Material Sources To Create New Polyester Fiber
- Massage Gun, Drawstring, Cord Fastner Are Not rPET
- Features A Type-C Input (Cord Included)
- 800 mAh Lithium Ion Grade A Battery

#85028 HANDHELD MASSAGER WITH ROLLERS

- Glides Smoothly Along Body
- Supports Responsible Forestry
- FSC® Certified
- FSC® Certified Products Are Made With, Or Contain, Forest-Based Materials Sourced From Forests That Have Been Audited By An Independent Third Party To Confirm They Are Managed According To FSC®'s Rigorous Social And Environmental Standards.

#85032 EYE PILLOW

- Eye Pillow Made Of Polyester
- Flaxseed/Clay Beads Filling
- Microwavable
- Reusable

#85021 EYE MASK

- Made Of Polyester
- Great For Travel
- Padded Eye Mask For Rest And Relaxation



#85028



#85032

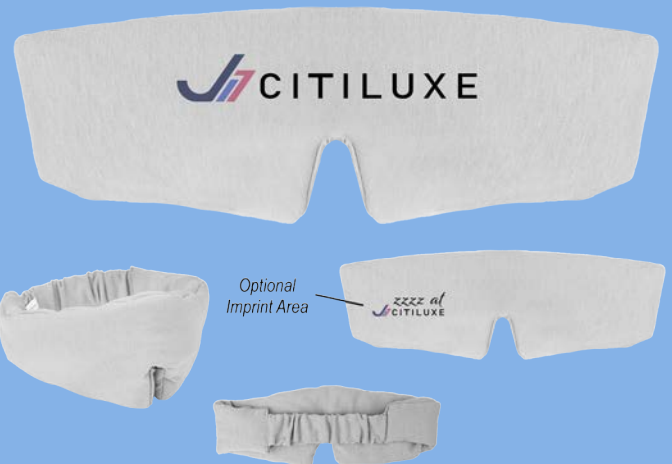

#85021

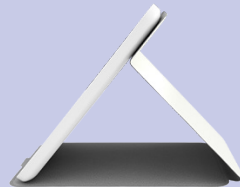
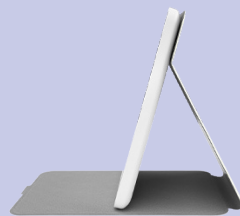

**#85024 MIRROR WITH LED LIGHT**

- Extra Bright White LED Light
- Push Button To Turn On/Off
- 3 Dimmable Light Settings - Cool, Warm And Bright
- Tap And Hold To Increase Or Decrease Light Brightness When Light Is On
- Back Cover Doubles As Mirror Stand
- Features A USB A Type-C Input (Cord Included)
- 1500 mAh Rechargeable Battery Included

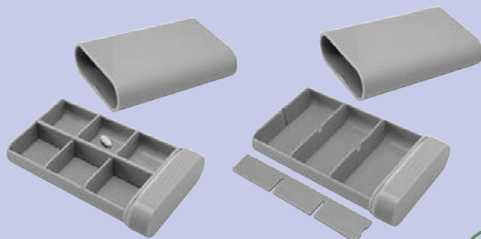

**#85029 RABS PILL CASE**

- 3 Separate Compartments
- Included Removable Divider Divides Each Compartment Creating 6 Separate Compartments
- Made Of rABS · Recycled ABS (Acrylonitrile Butadiene Styrene) Is Obtained By Melting Down Post Consumer ABS Plastic To Create New ABS Plastic
- Meets FDA Requirements



**#85025 TRAVEL PILLOW**

- Pillow For Travel Comfort
- Fits Into Case For Convenient Storage



#90065



#85022

Extended



#85027

#90065 - 10 PC. DENTAL FLOSSER PICK KIT  
 · Includes 10 Individual Flosser Picks In Reusable Travel Case  
 · Dental Floss On One End, Toothpick On The Other

#85022 EXTENDABLE BACK SCRATCHER  
 · Made Of Stainless Steel With PVC Handle

#85027 HOT/COLD PACK  
 · Therapeutic Gel Pack Applies Heat Or Cold To Sore Muscles  
 · Microwave And Freezer Safe · Reusable And Non-Toxic  
 · Instructions Printed On Reverse Side





**#85026 BAMBOO SEWING KIT WITH MIRROR**

- Kit Includes: 6 Pre-Threaded Needles (Black, Green, Red, Yellow, Pink And White), 2 White Buttons, 1 Needle, One Threader And One Safety Pin
- Supports Responsible Forestry · FSC® Certified
- FSC® Certified Products Are Made With, Or Contain, Forest-Based Materials Sourced From Forests That Have Been Audited By An Independent Third Party To Confirm They Are Managed According To FSC®'s Rigorous Social And Environmental Standards.



**#85023 BAMBOO NAIL FILE**

- Shape And Smooth Nail Edges
- Supports Responsible Forestry · FSC® Certified
- FSC® Certified Products Are Made With, Or Contain, Forest-Based Materials Sourced From Forests That Have Been Audited By An Independent Third Party To Confirm They Are Managed According To FSC®'s Rigorous Social And Environmental Standards.



**#90063 BAMBOO LIP MOISTURIZER STICK**

- Vanilla Flavor
- Safety Sealed
- Meets FDA Requirements



Top View

Side View

**#90062 BAMBOO LIP MOISTURIZER BALL**

- Vanilla Flavor
- Safety Sealed
- Meets FDA Requirements



#85016 SAFE TRAVELS FIRST AID KIT

- Kit Includes 4 Short Adhesive Bandages, 4 Large Adhesive Bandages, 2 Alcohol Wipes And 1 Each Antiseptic Towelette, Insect Sting Relief Pad, Burn Gel, SPF 15 Lip Balm And Instant Hand Sanitizer
- Convenient Travel Size PVC Pouch With Plastic J-Hook Attachment



#85019 SUN CARE & FIRST AID KIT

- Kit Includes 1 Packet Each Antiseptic Towelette, Insect Sting Relief Pad, Aloe After Sun Gel And Hand Sanitizer, 2 Packets Each SPF 30 Sunscreen Lotion And Adhesive Bandages
- Flip-Top Container With Carabiner Attachment
- Great For The Outdoors, Traveling, And Having On Hand For First Aid Emergencies



#85020 - 20 PC. FIRST AID KIT

- Includes 5 Adhesive Bandages, 4 Alcohol Pads, 2 Safety Pins, 5 Gauze Pads, 1 Gauze Roll, 1 Paper Tape Roll, Scissors And 1 Triangular Bandage
- Zippered Pouch With Front Slip Pocket And Belt Loop On Back



# TOOLS, LIGHTS & KEYPAGS

Cigar Not Included



#20072

## #20072 SMOKE SHOW 50 GAUGE CIGAR CUTTER

- Stainless Steel Blade
- Not Compatible With Cigars Larger Than 9/10"
- Slide Either End To Extend Or Retract Blade

## #20084 STRETCH CORD HOOK WITH CARABINER

- Made Of ABS And Nylon Rope
- 7" Rope · Supports Items Up To 4 1/2 Lbs.
- Carabiner Attachment · Portable
- Hook For Compact Carrying



#20084



Items Not Included





**#20067 COB POP-UP RECHARGEABLE LANTERN**

- 3 Extra Bright White COB Strips · 220 Lumens
- Lights Up Automatically When Opened And Turns Off When Collapsed
- Slide Up Or Down To Control The Brightness
- Convenient Hooks For Easy Hanging
- 1200 mAh Battery Capacity
- 3 Hour Charging Time · Up to 12 Hours Of Use
- Recharges Via The Supplied Type-C Cable
- Features A Type-C Input (Cord Included)

**#20068 LED POP-UP RECHARGEABLE LANTERN**

- Extra Bright White LED Light · Push Button To Turn Light On/Off
- 3 Light Settings - High, Low And Flashing
- Collapsible When Not In Use For Easy Storage
- Convenient Hook For Easy Hanging · 1200 mAh Battery Capacity
- Recharges Via The Supplied Type-C Cable
- Features A Type-C Input (Cord Included)



Closed

Extended

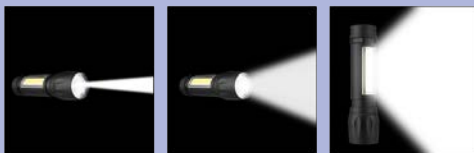

**#20066 TORCH RECHARGEABLE FLASHLIGHT**

- Made Of ABS
- Extra Bright White COB Worklight And LED Flashlight
- Pocket Clip · Push Button To Turn On/Off
- Flashlight Head Extends For Spotlight And Pushes Back For Floodlight
- Recharges Via The Supplied Type-C Cable
- 400mAh Battery Included
- Features A Type-C Input (Cord Included)

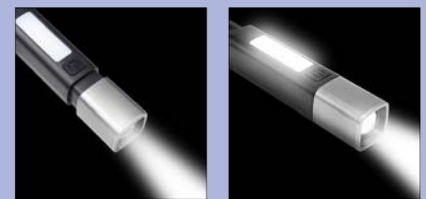

**#20092 TRAILBLAZER RECHARGEABLE COB FLASHLIGHT**

- Made Of ABS
- Extra Bright White LED Flashlight and Extra Bright White COB Light
- Carabiner Attachment · Push Button To Turn On/Off
- 3 Light Settings - Bright, Flashing And Side Light
- Recharges Via The Supplied Type-C Cable
- 600mAh Battery Included
- Features A Type-C Input (Cord Included)



#20052

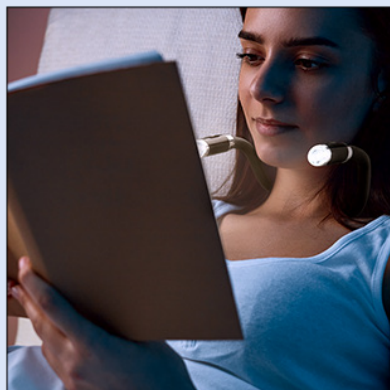

#20065



**#20052 RECHARGEABLE COB HEADLAMP**

- Made Of ABS And Silicone
- Extra Bright White COB Light
- 3 Light Settings - High, Low and Flashing
- Adjustable Head Strap
- Hand Motion Sensor Light
- Wave Hand In Front Of The Light To Turn The Light On And Wave Again To Turn The Light Back Off With The Motion Sensor Button
- Rechargeable Polymer Battery Included

**#20065 LED NECK LIGHT**

- Made Of ABS
- Extra Bright White LED Light
- Bendable Arms
- Push Button On Each Light To Turn On/Off
- Features Ergonomic Grip
- 2 Replaceable AAA Batteries Included



#20086 RECHARGEABLE VINTAGE BULB LIGHT

- Made Of ABS
- Extra Bright White LED Light
- 2 Filament, 60 Lumen Light Bulb
- Carabiner Attachment
- Push Button To Turn On/Off
- 3 Light Settings - High, Medium And Low
- Recharges Via The Supplied Type-C Cable
- 400 mAh Battery Included
- Features A Type-C Input (Cord Included)



#20078 2-IN-1 RECHARGEABLE FLASHLIGHT AND LAMP

- Made Of ABS
- Extra Bright White LED Light
- 1 Click For Flashlight, 2 Clicks For Lamp And 3 Clicks To Turn Off
- Light Folds Down When Not In Use
- Recharges Via The Supplied Type-C Cable
- 500 mAh Battery Included
- Features A Type-C Input (Cord Included)



#20074 HANDYMAN MAGNETIC WRISTBAND

- Made Of Polyester
- Includes 9 Strong Magnets For Metal Tools To Easily Attach
- One Size Fits Most
- Hook And Loop Closure
- Spot Clean/Air Dry



Magnetic Wristband Securely Holds Nails And Small Tools While You Work

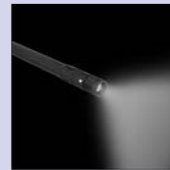

#20080 - 7-IN-1 EMERGENCY MULTI TOOL FLASHLIGHT

- Includes: Telescopic LED Flashlight, Ballpoint Pen, Pen Clip, Whistle, Phillips Head Screwdriver, Bottle Opener And Window Breaker
- Extra Bright White LED Light · Push Button To Turn On/Off
- Adjustable Light with Push/Pull Zoom
- Steel Pointed Head To Shatter Glass Easily
- Replaceable 3 Button Cell Batteries Included

#20107 FLIP 7-IN-1 MULTI TOOL

- Includes Tape Measure, 3 Flat Head And 3 Phillips Head Bits
- Head Bits Are Stored In Clear Compartment
- 3' Retractable Steel Tape
- Metric/Inch Scale
- Magnetic Port For Accepting Bits



20071 - 6-IN-1 MULTI TOOL WITH LED LIGHT

- Made Of ABS And Stainless Steel · 3 Flat Head And 3 Phillips Head Bits
- Extra Bright White LED Light · Extra Bright White COB Light
- Push Flashlight Button Once For Front Light, Push Again For Back Light, Push Again To Power Off
- Button Cell Batteries Included



#20059 - 6" RULER WITH LEVEL

- 3 Levels
- Metric/Inch Scale Ruler With 6" Markings
- Magnet On Bottom

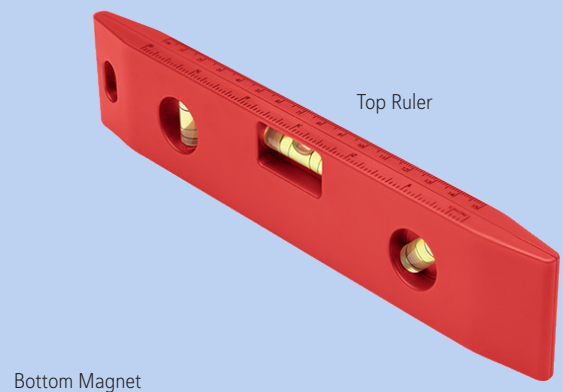

Top Ruler

Bottom Magnet





#20075 SWIFT 4-IN-1 MULTI TOOL KEY CHAIN

- Includes Tape Measure, Bottle Opener, 1 Flat Head And 1 Phillips Head Screwdrivers
- 3' Retractable Steel Tape · Metric/Inch Scale · Split Ring Attachment



Bottle Not Included

#20076 SCOUT 4-IN-1 MULTI TOOL KEY CHAIN

- Includes Tape Measure, Level And 1 Flat Head And Phillips Head Bits
- Head Bits Are Stored In A Slide Compartment
- 3' Retractable Steel Tape
- Metric/Inch Scale
- Split Ring Attachment



#20077 AXIS 3-IN-1 MULTI TOOL KEY CHAIN

- Includes Tape Measure, Level And Bottle Opener
- 3' Retractable Steel Tape
- Metric/Inch Scale
- Split Ring Attachment





- #20090 RECHARGEABLE LED LIGHT KEY CHAIN**
- Extra Bright White LED Light · Carabiner Attachment
  - Twist To Turn Light On And Off · 1 Light Setting
  - Removable Cap Features Rechargeable USB A
  - Connect To Any Standard USB Device



- #20091 SLIM RECHARGEABLE COB FLASHLIGHT**
- Made Of ABS And Aluminum · Extra Bright White COB Light
  - Ultra Slim Carabiner Attachment
  - Push Button To Turn On/Off
  - 3 Light Settings - High, Low And Flashing
  - Recharges Via The Supplied Type-C Cable
  - Features A Type-C Input (Cord Included)
  - 80mAh Battery Included
  - Ideal For Key Chains, Belts, Backpacks And More

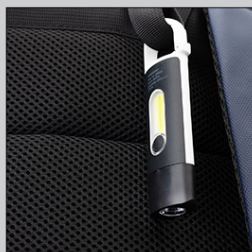

- #20058 RECHARGEABLE CARABINER COB FLASHLIGHT**
- Extra Bright White COB Worklight And LED Flashlight
  - Push Button To Turn On/Off
  - 3 Light Settings - High, Low And Flashing
  - Carabiner Attachment
  - Recharges Via The Supplied Type-C Cable
  - 200 mAh Battery Included
  - Features A Type-C Input (Cord Included)



Items Not Included



Back

**#75079 TOWEL & WATER BOTTLE HOLDER CARABINER**

- Slide Towel Through Soft Silicone Grips For Convenient Carrying
- Pull-Out Ring Fits Standard Size Water Bottle Caps
- Spring Clip Carabiner For Attaching To Bags, Belt Loops, Hooks, Etc.



**#20063 HARLEY LEATHERETTE POUCH KEY TAG**

- Split Ring Attachment
- Made Of Polyurethane And Zinc Alloy
- Zippered Closure



**#20094 MOTEL STYLE METAL KEY TAG WITH BOTTLE OPENER**

- Bottle Opener · Split Ring Attachment
- Zinc Alloy



**#20081 JARVIS WOOD KEY RING**

- Split Ring Attachment
- Distressed Look Hardware And Leatherette Accent
- Supports Responsible Forestry · FSC® Certified
- FSC® Certified Products Are Made With, Or Contain, Forest-Based Materials Sourced From Forests That Have Been Audited By An Independent Third Party To Confirm They Are Managed According To FSC's Rigorous Social And Environmental Standards.



**#20082 BRISTOL BAMBOO KEY TAG WITH BOTTLE OPENER**

- Bottle Opener · Split Ring Attachment
- Zinc Alloy



**#20089 SMITH RPET KEY TAG**

- Split Ring Attachment
- Made From Post Consumer Recycled Materials
- Recycled Polyester (rPET) is Obtained By Melting Down Existing Plastic Bottles And Other Material Sources To Create New Polyester Fiber
- Split Ring And Zinc Alloy Accent Is Not rPET



20083 PARKER LEATHERETTE KEY TAG  
 · Split Ring Attachment  
 · Made Of Polyurethane And Zinc Alloy



20073 PAXTON LEATHERETTE KEY TAG  
 · Split Ring Attachment  
 · Made Of Polyurethane And Aluminum



#20064 LEATHERETTE CARABINER CLIP KEY TAG  
 · Carabiner Clip Attachment  
 · 3 Mini Split Ring Attachments  
 · Made Of Polyurethane And Zinc Alloy



#20062 EVERTON SILICONE KEY RING  
 · Split Ring Attachment  
 · Made Of Silicone



#20106 INTREPID TUMBLER SHAPED SILICONE KEY RING  
 · Split Ring Attachment  
 · Made Of Silicone



#20101



#20102



#20103



#20105



#20104



- #20101 ACRYLIC MOTEL KEY TAG
- #20102 ACRYLIC KEY TAG - SQUARE
- #20103 ACRYLIC KEY TAG - CIRCLE
- #20104 ACRYLIC KEY TAG - HOUSE
- #20105 ACRYLIC KEY TAG - HEART
- Features Full Color Edge-To-Edge Graphics
- Split Ring Attachment
- Made In USA

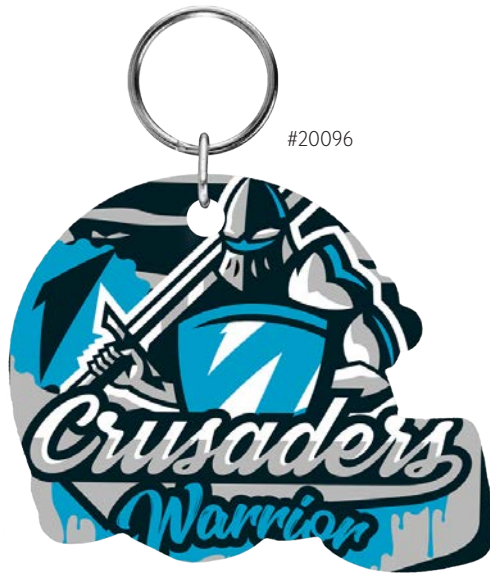

#20096



#20097



#20098



#20099



#20100



- #20096 ACRYLIC KEY TAG - CUSTOM SHAPE 6"
- #20097 ACRYLIC KEY TAG - CUSTOM SHAPE 5"
- #20098 ACRYLIC KEY TAG - CUSTOM SHAPE 4"
- #20099 ACRYLIC KEY TAG - CUSTOM SHAPE 3"
- #20100 ACRYLIC KEY TAG - CUSTOM SHAPE 2"
- Create Your Own Acrylic Key Tag Shape
- Features Full Color Edge-To-Edge Graphics
- Split Ring Attachment
- Made In USA



- #75208 ACRYLIC ZIPPER PULL - RECTANGLE
- #75209 ACRYLIC ZIPPER PULL - CIRCLE
- #75210 ACRYLIC ZIPPER PULL - STAR
- #75211 ACRYLIC ZIPPER PULL - SQUARE
- Features Full Color Edge-To-Edge Graphics
- Includes J-Hook For Attaching To Bags, Jackets Or Any Zippered Item
- Made In USA



#75208

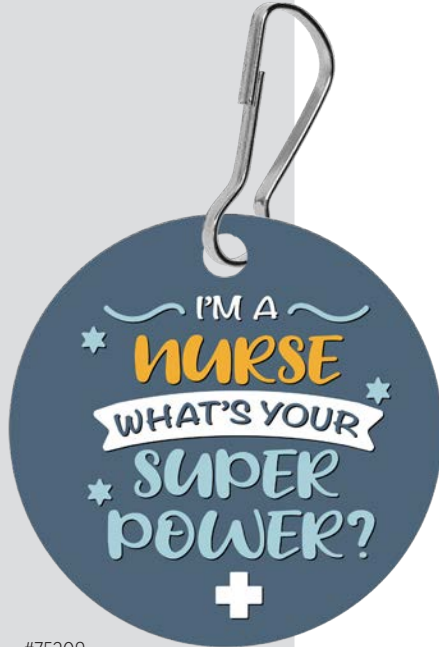

#75209  
Stock Design: Medical II



#75210  
Stock Design:  
GRADUATION2024\_13



#75211



- #75214 ACRYLIC ZIPPER PULL - CUSTOM SHAPE 2"
- #75213 ACRYLIC ZIPPER PULL - CUSTOM SHAPE 3"
- #75212 ACRYLIC ZIPPER PULL - CUSTOM SHAPE 4"
- Create Your Own Acrylic Zipper Pull Shape
- Features Full Color Edge-To-Edge Graphics
- Includes J-Hook For Attaching To Bags, Jackets Or Any Zippered Item
- Made In USA



#75214



#75213



#75212  
Optional Rainbow Holographic Design



#80020 HARD CASE WITH FOAM LINING - SMALL

- Made Of High Impact Polystyrene
- Protective Foam Insert
- Side Clips Keep Lid Secure



#80021 HARD CASE WITH FOAM LINING - LARGE

- Made Of High Impact Polystyrene
- Protective Foam Insert
- Side Clips Keep Lid Secure





# HITRONICS



#26252UL



TYPE-C



#26852



TYPE-C



#25216



#### #26252UL UL LISTED 2200 MAH ON-THE-GO POWER BANK 2.0

- Now With A Type-C Input (Cord Included)
- 2200 mAh Lithium Ion Grade A Non-Recycled Battery
- Red LED Light Indicator When Charging
- Output: 5 Volts/0.8 Amp
- Charges Most Devices
- Requires Your Phone's Charging Cord To Charge Your Device

#### #26852 - 1500 MAH ON-THE-GO POWER BANK 2.0

- Now With A Type-C Output And Input (Cord Included)
- 1500 mAh Lithium Ion Grade A Non-Recycled Battery
- Red LED Indicator Light When Charging
- Output: 5W
- Charges Most Devices
- Requires Your Phone's Charging Cord To Charge Your Device

#### #25216 - 2200 MAH RPET & BAMBOO POWER BANK

- Made With Bamboo And rPET Fabric
- Made From Post Consumer Recycled Materials
- Fabric Is rPET, Remaining Components Not Made Of Recycled Material
- Recycled Polyester (rPET) is Obtained By Melting Down Existing Plastic Bottles And Other Material Sources To Create New Polyester Fiber
- Indicator Light
- Features USB-A & Type-C Outputs And Type-C Input (Cord Included)
- Output: 5W · 2200 mAh Lithium Ion Grade A Battery
- Charging Time Approximately 3 Hours · Charges Most Devices
- Requires Your Phone's Charging Cord To Charge Your Device
- Supports Responsible Forestry · FSC® Certified
- FSC® Certified Products Are Made With, Or Contain, Forest-Based Materials Sourced From Forests That Have Been Audited By An Independent Third Party To Confirm They Are Managed According To FSC®'s Rigorous Social And Environmental Standards.



TYPE-C



RPET



TYPE-C

10w-20w

#25213 UL LISTED 5000 MAH PORTABLE POWER BANK

- UL Listed (Model# 25213/AST-MP632, File# E485248)
- Compatible With Apple® 8-Pin And Type-C Devices
- Indicator Lights
- Collapsible Kickstand On Back
- Built-In Cord Doubles As A Carrying Loop
- 5000 mAh Lithium Ion Grade A Non-Recycled Battery
- Output: 10W
- Features A Type-C Input (Cord Included)
- Charge Time Approximately 4-6 Hours
- Discharge Time Approximately 2-3 Hours
- Apple is a trademark of Apple Inc., registered in the U.S. and other countries.



#26558 - 10W MAG MAX WIRELESS CHARGER PHONE STAND

- Fast Charging Capability
- Adheres Magnetically To The Back Of Your Device  
(Requires Compatible Phone Case, Otherwise Remove Case To Use)
- Internal Magnets Help Properly Align Your Phone For Wireless Charging (iPhone® 12 & Newer)
- Flip Out Outer Ring For Use As A Phone Stand
- Features A Type-C (Cord Included) · Output: 10W
- Please Note That Some Computer And Laptop USB Ports May Not Supply Enough Power To Charge A Device Using This Charging Pad.
- Apple is a trademark of Apple Inc., registered in the U.S. and other countries.

Phone Not Included



TYPE-C

**#26890 - 3-IN-1 TRAVEL CHARGER**

- Compact And Portable Wireless Charging Mat
- Charge Qi Enabled Devices By Placing Device On Top Of Charging Mat
- Charge Phone, Earbuds, And Smart Watch Simultaneously
- Compatible With Apple® And Samsung Devices
- Output: 3W, 5W & 15W · Features A Type C Input (Cord Included)
- US Patented Item #D963,570 · Official Authorized Supplier
- Please Note That Some Computer And Laptop USB Ports May Not Supply Enough Power To Charge A Device Using This Charging Pad
- Apple and Lightning are registered trademarks of Apple Inc., registered in the U.S. and other countries
- Samsung is a registered trademark of Samsung Group, registered in the U.S. and other countries

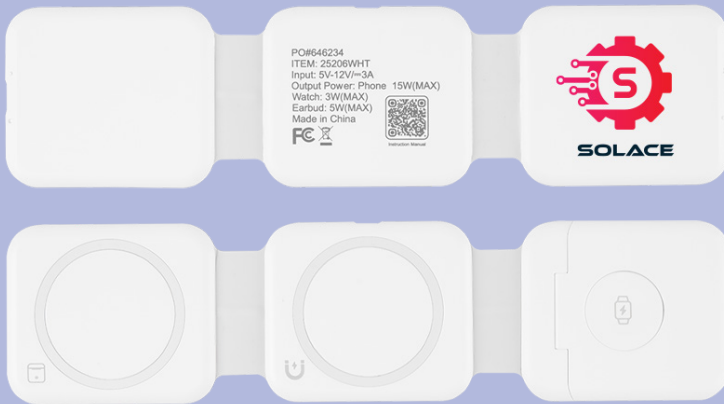

TYPE-C

**#25206 TRI-FOLD WIRELESS MULTI-CHARGER**

- Compact And Portable Wireless Charging Pads
- Charge Qi Enabled Devices By Placing Device On Top Of Charging Pad
- Charge Phone, Earbuds, And Smart Watch Simultaneously
- Compatible With Apple Watch® · Output: Up To 15W
- Features A Type C Input
- Type-C To Type-C Cord And Type-C To USB-A Adapter Included
- Please Note That Some Computer And Laptop USB Ports May Not Supply Enough Power To Charge A Device Using This Charging Pad
- Requires Your Phone's Charging Cord To Charge Your Device
- Apple and Apple Watch are trademarks of Apple Inc., registered in the U.S. and other countries



Items Not Included





10w-20w

#25224 RABS & BAMBOO WIRELESS CHARGER NIGHTLIGHT

- Made of Bamboo & rABS
- Recycled ABS (Acrylonitrile Butadiene Styrene) Is Obtained By Melting Down Post Consumer ABS Plastic To Create New ABS Plastic.
- Charge Qi Enabled Devices Wirelessly By Placing Compatible Device On Top Of Charging Pad
- Bright White LED Light · Push Button To Power Light On/Off
- Output: 15W · Features A Type-C Input (Cord Included)
- Please Note That Some Computer And Laptop USB Ports May Not Supply Enough Power To Charge A Device Using This Charging Pad



10w-20w

#22456 POWER UP 2-PORT USB HUB & CHARGING PAD 2.0

- Now With A Type-C Input And 15W Output
- Charge Qi Enabled Devices Wirelessly By Placing Compatible Device On Charging Pad
- Expand Available USB Ports On Your Computer For Additional Peripherals (Mouse, Keyboard, Printer, Etc.)
- Dual USB Output · LED Indicator Light



10w-20w

#28932 WIRELESS PHONE CHARGING PAD 2.0

- Now With A Type-C Input (Cord Included) And 15W Output
- Charge Qi Enabled Devices Wirelessly By Placing Compatible Device On Top Of Power Pad
- Indicator Light
- Please Note That Some Computer And Laptop USB Ports May Not Supply Enough Power To Charge A Device Using This Charging Pad.



Phone not included



#### #25247 RABS SMART WATCH POWER BANK

- Made Of rABS
- Recycled ABS (Acrylonitrile Butadiene Styrene) Is Obtained By Melting Down Post Consumer ABS Plastic To Create New ABS Plastic.
- 2000 mAh Lithium Ion Grade A Non-Recycled Battery
- Indicator Lights · Features A Type-C Input (Cord Included)
- Wireless Output: Up To 3W
- Compatible With Apple® And Samsung Smart Watches
- Apple is a trademark of Apple Inc., registered in the U.S. and other countries
- Samsung is a registered trademark of Samsung Group, registered in the U.S. and other countries

#### #25251 RABS MAGNETIC WIRELESS POWER BANK & WATCH CHARGER

- Made Of rABS · Recycled ABS (Acrylonitrile Butadiene Styrene) Is Obtained By Melting Down Post Consumer ABS Plastic To Create New ABS Plastic.
- Adheres Magnetically To The Back Of Your Device
- Internal Magnets Help Properly Align Your Phone For Wireless Charging (iPhone® 12 & Newer)
- 4000 mAh Lithium Ion Grade A Non-Recycled Battery
- Features A Type-C Input (Cord Included)
- Output: Watch 2W, Phone 5W
- Compatible With Apple® Watches
- Charging Time To Full Charge Approximately 4-6 Hours
- Apple is a trademark of Apple Inc., registered in the U.S. and other countries

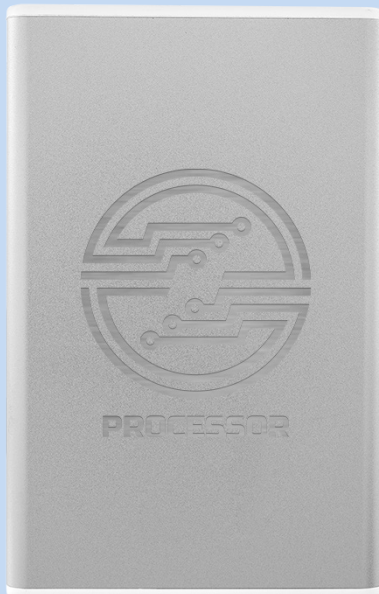

#### #25248 - 5000 MAH RABS & ALUMINUM POWER BANK

- Made Of Aluminum & rABS
- Recycled ABS (Acrylonitrile Butadiene Styrene) Is Obtained By Melting Down Post Consumer ABS Plastic To Create New ABS Plastic
- 5000 mAh Lithium Ion Grade A Non-Recycled Battery
- Features A USB-A & Type-C Outputs And Micro-USB Or Type-C Input (Type-C Cord Included)
- Charging Time Approximately 3-4-Hours
- Requires Your Phone's Charging Cord To Charge Your Device





10w-20w

#25182 - 15W MAG MAX POWER BANK

- Fast Charging Capability · Adheres Magnetically To The Back Of Your Device
- Internal Magnets Help Properly Align Your Phone For Wireless Charging (iPhone® 12 & Newer)
- Digital Power Level Indicator · Over Current, Over Voltage, Over Charge And Over Discharge Protection · 5000 mAh Lithium Ion Grade A Battery
- Output: 15W · Features A Type-C Input (Cord Included) · Charging Time 1 1/2 Hours
- Please Note That Some Computer And Laptop USB Ports May Not Supply Enough Power To Charge A Device Using This Charging Pad.
- Apple and iPhone are trademarks of Apple Inc., registered in the U.S. and other countries.



10w-20w

#25199 - 15W MAG MAX WIRELESS CHARGER POWER BANK

- Fast Charging Capability · Adheres Magnetically To The Back Of Your Device
- Internal Magnets Help Properly Align Your Phone For Wireless Charging (iPhone® 12 & Newer)
- Slim, Compact Profile · Digital Power Level Indicator
- Over Current, Over Voltage, Over Charge And Over Discharge Protection
- 5000 mAh Lithium Ion Battery · Wireless Output: 15W, USB-C Output: 22.5W
- Features A Type-C Input (Cord Included)
- Please Note That Some Computer And Laptop USB Ports May Not Supply Enough Power To Charge A Device Using This Charging Pad.
- Apple and iPhone are trademarks of Apple Inc., registered in the U.S. and other countries.

Phone Not Included



10w-20w

#25233 - 10,000 MAH WIRELESS CHARGER POWER BANK

- Fast Charging Capability · Instantly Powers On When Attached To iPhone®
- Adheres Magnetically To The Back Of Your Device
- Internal Magnets Help Properly Align Your Phone For Wireless Charging (iPhone® 12 & Newer)
- LED Digital Power Display
- Features USB-A & Type-C Outputs And Type-C Input (Cord Included)
- Wireless Output: Up To 15W, Type-C Output: 20W
- 10,000 mAh Lithium Ion Grade A Battery · Charging Time 2-3 Hours
- Please Note That Some Computer And Laptop USB Ports May Not Supply Enough Power To Charge A Device Using This Charging Pad
- Apple and iPhone are trademarks of Apple Inc., registered in the U.S. and other countries.



10w-20w

#25198 - 10,000 MAH POWER BANK WITH INTEGRATED CABLES

- Fast Charging Capability · Compatible With USB-C PD (Power Delivery) Devices
- Includes Flip-Out Lightning® And Type-C Cables · Indicator Lights
- 10,000 mAh Lithium Ion Grade A Non-Recycled Battery
- Output: 20W
- Features A USB-A Output And Lightning® And Type-C Inputs (Adapters Built In)
- Charging Time Approximately 3 Hours
- Charges Most Devices
- Charge Multiple Devices At Once When Using An Ample Power Source
- Apple and iPhone are trademarks of Apple Inc., registered in the U.S. and other countries.



#25246 - 10,000 MAH POWER BANK WITH BUILT-IN CABLES ...

- Fast Charging Capability
- 10,000 mAh Lithium Ion Grade A Non-Recycled Battery
- Digital Power Level Indicator
- Output: 20W
- Features A USB-A & Type-C Outputs And Type-C Input (Cords Built In)
- Charging Time Approximately 4-6 Hours



#25234 - 100W SUPER CHARGE POWER BANK

- Fast Charging Capability
- Digital Power Level Indicator
- Features A USB-A & Type-C Output And Type-C Input (Cord Built-In)
- Output: Type-C 100W, USB-A 22.5W



#28962 CHI-CHARGE PRO 10,000 MAH POWER BANK

- Charge Qi Enabled Devices Wirelessly By Placing Compatible Device On Top Of Power Bank
- 10,000 mAh Mah Lithium Ion Grade A Non-Recycled Battery
- Built-In Cables: Lightning® Compatible, Micro-USB, And Type-C
- Built-In Wall Plug
- PD (Power Delivery) With Total 28.5W
- One USB Output
- Charge Phone From 0% To 50% In 30 Minutes
- Apple and Lightning are trademarks of Apple Inc., registered in the U.S. and other countries.



**#25245 RABS POCKET SIZE POWER BANK**

- Made Of rABS · Recycled ABS (Acrylonitrile Butadiene Styrene) Is Obtained By Melting Down Post Consumer ABS Plastic To Create New ABS Plastic
- 2000 mAh Lithium Ion Grade A Non-Recycled Battery
- Loop For Carrying
- Features A Type-C Output And Input (Cord Built-In)
- Charging Time To Full Charge Approximately 3-5 Hours



Phone Not Included

TYPE-C

10w-20w

**#25194 - 10,000 MAH 5-IN-1 UNIVERSAL CHARGER**

- Includes Wall Charger, Magnetic Wireless Charger, Power Bank, Built-In Charging Cable And Phone Holder
- Charge Qi Enabled Devices Wirelessly By Placing Compatible Device On Charging Pad
- Internal Magnets Help Properly Align Your Phone For Wireless Charging (iPhone® 12 & Newer)
- 10,000 mAh Lithium Ion Battery
- Wireless Output 15W
- Features Type-C, USB-A And Lightning® Outputs And Type-C And A/C Inputs
- Apple, Lightning and iPhone are trademarks of Apple Inc., registered in the U.S. and other countries.



**#25167 - 65W POWER CUBE WALL ADAPTER**

- Compact Design With Folding Prongs
- Features AC Input And 1 USB & 2 Type-C Outputs
- 65W Power Delivery
- Quickly & Efficiently Charges Most Phones, Laptops & MacBooks
- Requires Your Phone's Charging Cord To Charge Your Device
- MacBook is a trademark of Apple Inc., registered in the U.S. and other countries



**#25244 - 30W WALL ADAPTER**

- Features USB-A & Type-C Output And AC Input
- Quickly & Efficiently Charges Most Devices
- Type-C Output: 30W Power Delivery
- Requires Your Phone's Charging Cord To Charge Your Device





Phone Not Included



10w-20w

- #24482 WIRELESS CHARGING PAD PHONE STAND 2.0
- Now With A Type-C Input (Cord Included) And 10W Output
  - Charge Qi Enabled Devices Wirelessly By Placing Compatible Device On Stand
  - Adjustable Stand Has 5 Height Positions
  - Non-Slip Base
  - Please Note That Some Computer And Laptop USB Ports May Not Supply Enough Power To Charge A Device Using This Charging Pad.



Phone Not Included

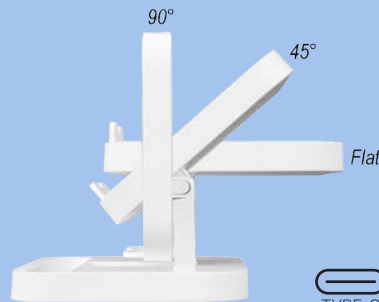

10w-20w



- #25186 - 15W RABS CHARGING PHONE STAND
- Made Of rABS
  - Recycled ABS (Acrylonitrile Butadiene Styrene) Is Obtained By Melting Down Post Consumer ABS Plastic To Create New ABS Plastic
  - Charge Qi Enabled Devices By Placing Compatible Device On Stand
  - Charge Your Device Vertically Or Horizontally
  - Folds Compact For Easy Travel & Storage
  - Holds A Variety Of Phone Sizes For Easy Viewing
  - Output: 15W
  - Features A Type-C Input (Cord Included)
  - Please Note That Some Computer And Laptop USB Ports May Not Supply Enough Power To Charge A Device Using This Charging Pad.



10w-20w

- #25236 - 5000 MAH STAND & DELIVER POWER BANK
- Fast Charging Capability
  - Adheres To The Back Of Your Device With An Ultra Strong N52 Magnet
  - Internal Magnets Help Properly Align Your Phone For Wireless Charging (iPhone® 12 & Newer)
  - Built-In Aluminum Alloy U-Shaped Stand
  - Compatible With Type-C PD (Power Delivery) Devices
  - LED Indicator Lights
  - 5000 mAh Lithium Ion Grade A Non-Recycled Battery
  - Features A Type-C Input (Type-C To Type-C Cord Included)
  - Wireless Output: 15W, Type-C Output: 20W
  - Please Note That Some Computer And Laptop USB Ports May Not Supply Enough Power To Charge A Device Using This Charging Pad.
  - Apple and iPhone are trademarks of Apple Inc., registered in the U.S. and other countries



Phone Not Included



Phone not included



TYPE-C

10w-20w

**#25900 - 10W WIRELESS CHARGER PHONE STAND**

- Charge Qi Enabled Devices Wirelessly By Placing Compatible Device On Top Of Charging Pad
- Holds A Variety Of Phone Sizes For Easy Viewing
- Output: 10W
- Features A Type-C Input (Cord Included)
- Please Note That Some Computer And Laptop USB Ports May Not Supply Enough Power To Charge A Device Using This Charging Pad.



Phone Not Included

10w-20w

**#25253 - 15W BAMBOO FOLDING CHARGER WITH DIGITAL CLOCK**

- Charge Qi Enabled Devices Wirelessly By Placing Compatible Device On Top Of Charging Pad
- Digital Display With 12 Or 24 Hour Clock Settings
- Pull Out Stand To Prop Up
- Features A Type-C Input (Cord Included)
- USB-A & Type-C Output: 15W · Requires Your Phone's Charging Cord To Charge Your Device



Phone Not Included



- #250152 MAG MAX BAMBOO MAGNETIC WIRELESS CHARGER 2.0
- Now With A Type-C Input (Cord Built-In) And 10W Output · Fast Charging Capability
  - Adheres Magnetically To The Back Of Your Device.
  - (Requires Compatible Phone Case, Otherwise Remove Case To Use)
  - Internal Magnets Help Properly Align Your Phone For Wireless Charging (iPhone® 12 & Newer)
  - FSC® Certified · Supports Responsible Forestry
  - FSC® Certified Products Are Made With, Or Contain, Forest-Based Materials Sourced From Forests That Have Been Audited By An Independent Third Party To Confirm They Are Managed According To FSC's Rigorous Social And Environmental Standards.
  - Please Note That Some Computer And Laptop USB Ports May Not Supply Enough Power To Charge A Device Using This Charging Pad.
  - iPhone is a trademark of Apple Inc., registered in the U.S. and other countries.



10w-20w



Phone Not Included



Phone Not Included



10w-20w

- #25165 MAG MAX BAMBOO WIRELESS CHARGER POWER BANK
- Fast Charging Capability · Made With Wheat Straw Plastic & Bamboo
  - Adheres Magnetically To The Back Of Your Device
  - Internal Magnets Help Properly Align Your Phone For Wireless Charging (iPhone® 12 & Newer)
  - 5000 mAh Lithium Ion Battery · Output: 5W
  - Features Type-C Input (Built-In Cord With Additional Lightning® Adapter)
  - Charging Time 2-3 Hours
  - Please Note That Some Computer And Laptop USB Ports May Not Supply Enough Power To Charge A Device Using This Charging Pad.
  - Apple, Lightning and iPhone are trademarks of Apple Inc., registered in the U.S. and other countries

- #25173 - 5000 MAH BAMBOO POWER BANK & 10W WIRELESS CHARGER
- Charge Qi Enabled Devices Wirelessly By Placing Compatible Device On Top Of Charging Pad
  - LED Indicator Light
  - 5000 mAh Lithium Ion Grade A Non-Recycled Battery
  - Wireless Output: 10W
  - Features 2 Type-C Inputs (Cord Included) And USB-A & Type-C Output
  - Charging Time 3 1/2 Hours
  - Please Note That Some Computer And Laptop USB Ports May Not Supply Enough Power To Charge A Device Using This Charging Pad



10w-20w

- #29822 TIMBER WIRELESS CHARGING PAD 2.0
- Now With A Type-C Input (Cord Included)
  - Charge Qi Enabled Devices Wirelessly By Placing Compatible Device On Top Of Charging Pad
  - LED Indicator Light
  - Output: 10W
  - Non-Slip Bottom



Phone Not Included



10w-20w

- #254022 ROLLING STONE WIRELESS CHARGING PAD 2.0
- Now With A Type-C Input (Cord Built-In) And 10W Output
  - Cement Mount With Bamboo Charging Pad
  - Charge Qi Enabled Devices Wirelessly By Placing Compatible Device On Top Of Charging Pad
  - FSC® Certified · Supports Responsible Forestry
  - FSC® Certified Products Are Made With, Or Contain, Forest-Based Materials Sourced From Forests That Have Been Audited By An Independent Third Party To Confirm They Are Managed According To FSC®'s Rigorous Social And Environmental Standards.
  - Please Note That Some Computer And Laptop USB Ports May Not Supply Enough Power To Charge A Device Using This Charging Pad.



- #25204 BAMBOO & RECYCLED FABRIC WIRELESS CHARGER
- Made With Bamboo And rPET Fabric
  - Made From Post Consumer Recycled Materials
  - Fabric Is rPET, Remaining Components Not Made Of Recycled Material
  - Recycled Polyester (rPET) is Obtained By Melting Down Existing Plastic Bottles And Other Material Sources To Create New Polyester Fiber
  - Charge Qi Enabled Devices Wirelessly By Placing Compatible Device On Top Of Charging Pad
  - LED Indicator Light · Output: 15W · Features A Type-C Input (Cord Included)
  - Charging Time Approximately 3 Hours
  - Please Note That Some Computer And Laptop USB Ports May Not Supply Enough Power To Charge A Device Using This Charging Pad.
  - FSC® Certified · Supports Responsible Forestry
  - FSC® Certified Products Are Made With, Or Contain, Forest-Based Materials Sourced From Forests That Have Been Audited By An Independent Third Party To Confirm They Are Managed According To FSC®'s Rigorous Social And Environmental Standards.



**#26362 RABS 4-PORT USB HUB 2.0**

- Now With 2 Type-C Outputs
- Made Of rBAS
- Recycled ABS (Acrylonitrile Butadiene Styrene) Is Obtained By Melting Down Post Consumer ABS Plastic To Create New ABS Plastic
- Expand Available USB Ports On Your Computer For Additional Peripherals (Mouse, Keyboard, Printer, Etc.)
- Features 2 USB-A Inputs · 2.0 Interface · Output: 5V 500mA



**#26751 - 20W SLIM WALL CHARGER**

- Features USB-A & Type-C Output And A/C Input
- Compact Design With Folding Prongs
- Input: 100-240 Volts, Output: 5 Volts/3 Amp
- Requires Your Phone's Charging Cord To Charge Your Device
- Charges Most Devices



**#25252 COMPACT MULTI-OUTLET POWER STRIP**

- Charge Up To 5 Devices Simultaneously
- Features 2 A/C Outlets, 1 Type-C And 2 USB-A Ports
- Cord Wraps Around For Compact Storage & Travel



Top



Press & Hold Button For Adapter Options



10w-20w

**#25263 INTERNATIONAL TRAVEL ADAPTER**

- Versatile Power Adapter Compatible With 4 Countries - AUS, EU, UK, USA
- Features A Type-C And 2 USB-A Inputs
- LED Indicator Light · Integrated Fuse · Output: 15W
- Requires Your Phone's Charging Cord To Charge Your Device

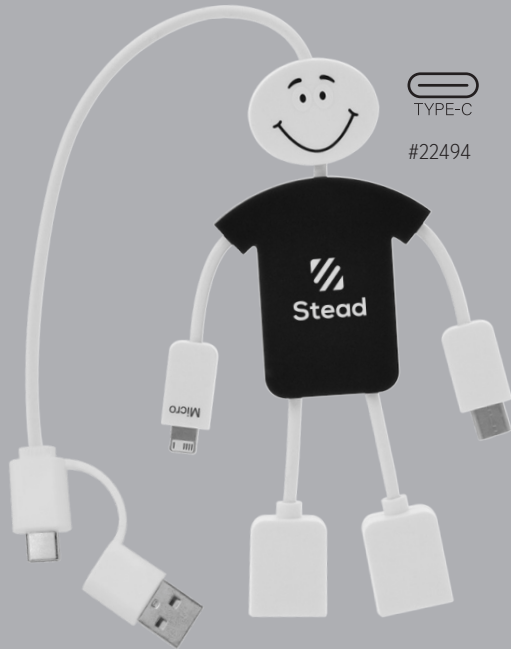

TYPE-C  
#22494



Made with Recycled Materials  
#25193



Items Not Included



TYPE-C  
#28292



TYPE-C  
#251562

#### #25193 RABS TYPE-C & USB HUB WITH PHONE STAND

- Made Of Recycled rABS
- Recycled ABS (Acrylonitrile Butadiene Styrene) Is Obtained By Melting Down Post Consumer ABS Plastic To Create New ABS Plastic.
- Expand Available USB Ports On Your Computer For Additional Peripherals (Mouse, Keyboard, Printer, Etc.)
- 2 High Speed USB-A Ports And 2 High Speed Type-C Ports
- Features USB-A And Type-C Inputs (Cord Attached And Stored Underneath)
- Slide-Out Phone Stand Holds A Variety Of Phone Sizes For Easy Viewing

#### #22494 TECHMATE 3-IN-1 CHARGING CABLE & USB HUB 2.0

- Now With A USB-A To Type-C Input Adapter
- Features Apple® 8-Pin, Micro-USB & Type-C Outputs And USB-A Or Type-C Inputs
- Simply Plug The Cable Into A Powered USB Port And Then Into Your Device
- 2 High Speed USB Ports
- Expand Available USB Ports On Your Computer For Additional Peripherals (Keyboard, Printer, Etc.)
- Charge Multiple Devices At Once When Using An Ample Power Source
- Apple is a trademark of Apple Inc., registered in the U.S. and other countries.

#### #28292 - 3-IN-1 BRAIDED CHARGING BUDDY 2.0

- Now With A USB-A To Type-C Input Adapter
- Features Apple® 8-Pin, Micro-USB & Type-C Outputs And USB-A Or Type-C Inputs
- Simply Plug The Cable Into A Powered USB Port And Then Into Your Device
- Charge Multiple Devices At Once When Using An Ample Power Source
- Apple is a trademark of Apple Inc., registered in the U.S. and other countries.

#### #251562 - 3 FT. 4-IN-1 CHARGING CABLE 2.0

- Now With A USB-A To Type-C Input Adapter
- Features Apple® 8-Pin, Micro-USB & Type-C Outputs And USB-A Or Type-C Inputs
- Simply Plug The Cable Into A Powered USB Port And Then Into Your Device Or Smartphone
- Charge Multiple Devices At Once When Using An Ample Power Source
- Apple is a trademark of Apple Inc., registered in the U.S. and other countries.



#25228 DUAL CONNECT RECYCLED MULTI-CHARGING CABLE

- Made Of Recycled PVC
- Features Apple® 8-Pin, Micro-USB & Type-C Outputs And USB-A Or Type-C Inputs
- Simply Plug The Cable Into A Powered USB Port And Then Into Your Device
- Charge Multiple Devices At Once When Using An Ample Power Source
- Apple is a trademark of Apple Inc., registered in the U.S. and other countries.

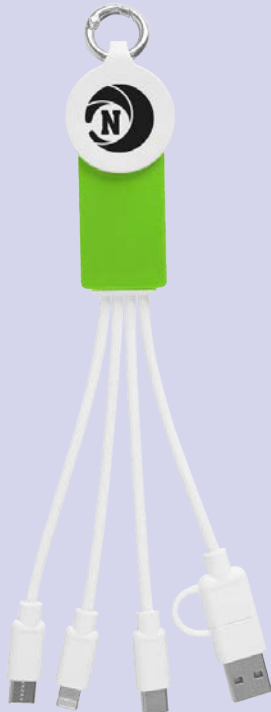

#25238 RABS MULTI-CHARGING CABLES WITH WATCH DOCK

- Made Of Aluminum & rABS
- Recycled ABS (Acrylonitrile Butadiene Styrene) Is Obtained By Melting Down Post Consumer ABS Plastic To Create New ABS Plastic.
- Features Apple® 8-Pin, Micro USB, Type-C, And Magnetic Watch Charger Outputs And USB-A Or Type-C Inputs
- Simply Plug The Cable Into A Powered USB Port And Then Into Your Device
- Charge Multiple Devices At Once When Using An Ample Power Source
- Output: 2.5W · Compatible With Apple® And Samsung Smart Watches
- Apple is a trademark of Apple Inc., registered in the U.S. and other countries
- Samsung is a registered trademark of Samsung Group, registered in the U.S. and other countries



#25223 - 65W MAGNETIC QUICK CHARGE CHARGING CABLE

- Fast Charging Capability
- Adapters Connect Magnetically For Convenient Travel & Storage
- Features Apple® 8-Pin, Micro-USB or Type-C Outputs & USB-A Or Type-C Inputs
- Simply Plug The Cable Into A Powered USB-A Or Type-C Port And Then Into Your Device
- USB-A Output: 20W Power Delivery; Type-C Output: 65W
- Supports Data Transfer
- Apple is a trademark of Apple Inc., registered in the U.S. and other countries.



#25230 - 5' RECYCLED CHARGING CABLE

- Made Of Recycled PVC
- Features Apple® 8-Pin, Micro USB & Type-C Outputs And USB-A Or Type-C Inputs
- Simply Plug The Cable Into A Powered USB Port And Then Into Your Device Or Smartphone
- Charge Multiple Devices At Once When Using An Ample Power Source
- Apple is a trademark of Apple Inc., registered in the U.S. and other countries.

MEGA  
BRITE



Back

#### #25221 - 100W QUICK CHARGE MULTI-CABLE

- Features Apple® 8-Pin, Micro USB & Type-C Outputs And USB-A Or Type-C Inputs
- Simply Plug The Cable Into A Powered USB Port And Then Into Your Device
- Charge Multiple Devices At Once When Using An Ample Power Source
- Apple is a trademark of Apple Inc., registered in the U.S. and other countries.



#### #25257 MULTI-CHARGE CABLES WITH ROUND CARABINER

- Features Apple® 8-Pin, Micro USB Or Type-C Outputs And USB-A Or Type-C Inputs
- Simply Plug The Cable Into A Powered USB-A Or Type-C Port And Then Into Your Device
- Round Carabiner For Attaching To Bags, Belt Loops, Keys, Etc.
- Apple is a trademark of Apple Inc., registered in the U.S. and other countries.

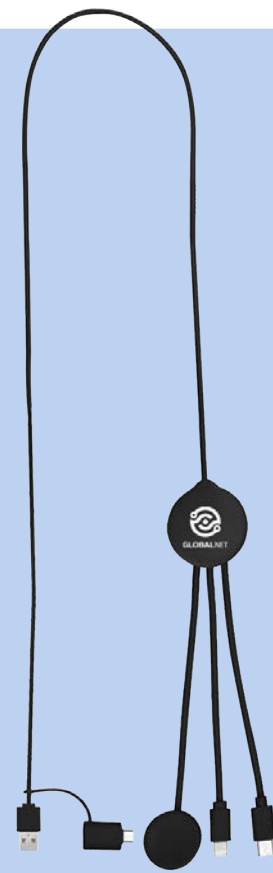

#### #25226 MULTI-CHARGING CABLE WITH WATCH DOCK

- Features Apple® 8-Pin, Micro USB, Type-C, And Magnetic Watch Charger Outputs And USB-A Or Type-C Inputs
- Simply Plug The Cable Into A Powered USB Port And Then Into Your Device
- Charge Multiple Devices At Once When Using An Ample Power Source
- Apple is a trademark of Apple Inc., registered in the U.S. and other countries



#### #25208 USB-A TO TYPE-C ADAPTER

- Aluminum Casing
- Converts USB-A Cable To Type-C Connector





- #95102 NOISE CANCELLING HEADPHONES WITH TRAVEL POUCH**
- Kit Includes #25159 Noise Cancelling Headphones And #25612 rPET Tech Travel Pouch
  - Price Includes 1-Color/1-Location Imprint On Each Item.



 TYPE-C

- #25232 OPEN EAR TWS EARBUDS WITH CHARGING CASE**
- Over The Ear Design For Added Stability
  - Features High Definition Bluetooth® 5.0 Wireless Technology And Dual Built-In Microphones With Volume Control
  - Simply Pair With Your Device To Enjoy Dynamic Stereo Sound Or Receive Hands-Free Calls
  - Works With Most Audio Devices · Hands-Free Design
  - Press Earbuds To Advance Through Selections And Answer/End Calls
  - Store Earbuds In Magnetic Charging Base · LED Digital Power Display
  - Features A Type-C Input (Cord Included)
  - Charging Time Approximately 1 1/2 - 2 hours · Up To 4 Hours Play Time
  - Pairs From Up To 33 Feet Away



 TYPE-C

- #25217 WIRELESS EARBUDS WITH DIGITAL POWER DISPLAY**
- Features High Definition Bluetooth® 5.3 Wireless Technology And Built-In Microphone With Volume Control
  - Simply Pair With Your Device To Enjoy Dynamic Stereo Sound Or Receive Hands-Free Calls
  - Hands-Free Design · LED Digital Power Display
  - Press Earbuds To Advance Through Selections And Answer/End Calls
  - Store Earbuds In Magnetic Charging Base
  - Features A Type-C Input (Cord Included) · Pairs From Up To 32 Feet Away
  - Charging Time Approximately 1-2 Hours · Up To 5 Hours Play Time
  - Output: 5 Volts/200mA



 TYPE-C

- #25157 BAMBOO WIRELESS EARBUDS & WATCH CHARGER**
- Charge Earbuds And Apple Watch® Simultaneously
  - Features High Definition Bluetooth® 5.3 Wireless Technology And Built-In Microphone With Volume Control
  - Simply Pair With Your Device To Enjoy Dynamic Stereo Sound Or Receive Hands-Free Calls · Store Earbuds In Magnetic Charging Base
  - Press Earbuds To Advance Through Selections And Answer/End Calls
  - Hands-Free Design · Works With Most Audio Devices
  - 400 mAh Lithium Ion Battery · Output: 2.5W
  - Features A Type-C Input (Cord Included)
  - Apple is a trademark of Apple Inc., registered in the U.S. and other countries.



#### #25515 MAG MAX MONITOR MOUNT WIRELESS CHARGER

- Fast Charging Capability
- Provides Dual Screen Interaction Between Phone And Computer
- Suitable For Laptop Or Desktop Monitors
- Adheres To Back Of Your Monitor With Strong Adhesive
- Magnetic Pad Keeps Phone In Place (Requires Compatible Phone Case, Otherwise Remove Case To Use)
- Internal Magnets Help Properly Align Your Phone For Wireless Charging (iPhone® 12 & Newer)
- Swivels Closed When Not In Use
- Output: 15W
- Features A Built-In Type-C Cable
- iPhone is a trademark of Apple Inc., registered in the U.S. and other countries.



Laptop & Phone Not Included



#### #25231 PHONE & WATCH WIRELESS CHARGER STAND

- Charge Qi Enabled Devices Wirelessly By Placing Compatible Device On Top Of Charging Pad
- Simply Connect Built-In Cord To Power Source To Charge Phone & Watch
- Compatible With Apple Watch®
- Pull-Out Phone Stand Holds A Variety Of Phone Sizes For Easy Viewing
- Indicator Light
- Features A Type-C Input (Cord Built-In)
- Includes Apple® 8-Pin, Micro-USB, And USB-A Adapters
- Cord & Adapters Store Inside Case
- Includes SIM Card Slot For Storage And Ejection Pin
- Output: Phone 15W, Watch 3W
- Please Note That Some Computer And Laptop USB Ports May Not Supply Enough Power To Charge A Device Using This Charging Pad
- Apple and Apple Watch are trademarks of Apple Inc., registered in the U.S. and other countries

Watch Not Included

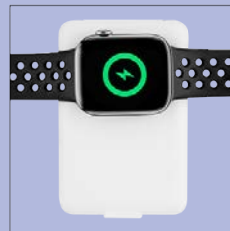

Phone Not Included



Cord Not Included

#### #25001 TIMEKEEPER SMART WATCH STAND

- Compatible With Apple® And Samsung Smart Watches
- Pull-Out Phone Stand Holds A Variety Of Phone Sizes For Easy Viewing
- Requires Your Phone's Charging Cord To Charge Your Device
- Apple Watch is a trademark of Apple Inc., registered in the U.S. and other countries
- Samsung is a registered trademark of Samsung Group, registered in the U.S. and other countries



**#24812 BAMBOO WIRELESS LIGHT UP SPEAKER 2.0**

- Now With An Upgraded Grille Design And A Type-C Input (Cord Included)
- Wireless Speaker Featuring High Definition Bluetooth® 3.0 Technology
- Simply Pair Your Device To Enjoy Dynamic Stereo Sound
- Bright White LED Illuminates Base When In Use
- Pairs From Up To 30 Feet Away



**#256002 ULTRA SOUND SPEAKER & WIRELESS CHARGER 2.0**

- Now With A Type-C Input (Cord Included) And 10W Output
- Charge Qi Enabled Devices Wirelessly By Placing Compatible Device On Top Of Charging Pad
- Wireless Speaker Featuring High Definition Bluetooth® 5.1 Technology
- Simply Pair With Your Device To Enjoy Dynamic Stereo Sound
- LED Light Illuminates When in Use · 1800 mAh Lithium Polymer Battery
- Pairs From Up To 30 Feet Away · Up To 8 Hours Of Play Time

Optional Imprint Area



**#24462 ALLEGRO WOOD GRAIN WIRELESS SPEAKER 2.0**

- Now With A Type-C Input (Cord Included)
- Wireless Speaker Featuring High Definition Bluetooth® 4.1 Technology
- Simply Pair Your Device To Enjoy Dynamic Stereo Sound
- 300 mAh Lithium Polymer Battery
- Pairs From Up To 30 Feet Away · Up To 1 1/2 Hours Of Play Time
- Perfect For Your Home, Office Or Outdoor Activities



**#25203 RECYCLED ALUMINUM WIRELESS SPEAKER**

- Made With Bamboo & Recycled Aluminum
- Wireless Speaker Featuring High Definition Bluetooth® 5.1 Technology
- Simply Pair With Your Device To Enjoy Dynamic Stereo Sound
- Features A Type-C Input (Cord Included)
- 300 mAh Lithium Ion Grade A Battery · Pairs From Up To 33 Feet Away
- Charging Time Approximately 1 1/2 Hours
- Up To 2 Hours Of Play Time · FSC® Certified
- Supports Responsible Forestry
- FSC® Certified Products Are Made With, Or Contain, Forest-Based Materials Sourced From Forests That Have Been Audited By An Independent Third Party To Confirm They Are Managed According To FSC®'s Rigorous Social And Environmental Standards.



#252902 SOUND ASLEEP BAMBOO WHITE NOISE MACHINE & SPEAKER 2.0

- Now With A Type-C Input (Cord Included)
- Made Of ABS With Bamboo Face
- Includes 6 Soothing Sounds - Bird Chirps, Rainy Day, Fireside, White Noise, Ocean Waves And Windy Breeze
- Features Time Span Options Or Continuous Play (Instructions Included)
- Wireless Speaker Featuring High Definition Bluetooth® 5.3 Technology
- Simply Pair With Your Device To Enjoy Dynamic Stereo Sound
- LED Indicator Lights
- 300 mAh Lithium Polymer Battery
- Pairs From Up To 30 Feet Away
- Up To 2 Hours Of Play Time



#25225 MINI LAMP WITH SPEAKER & SOUND MACHINE

- Bamboo & ABS With Fabric Grille
- Features High Definition Bluetooth® 5.3 Wireless Technology
- Simply Pair With Your Device To Enjoy Dynamic Stereo Sound
- Bright White LED Light With 3 Light Settings - Low, Medium & High
- 8 Soothing Sounds To Choose From - Brook Noise, Bird Chirp, Forest Bird, White Noise, Ocean Wave, Rainy Day, Wind & Fireside
- Push Button To Power On/Off And Choose Settings
- Features A Type-C Input (Cord Included)
- 1800 mAh Lithium Ion Grade Battery Included
- Pairs From Up To 32 Feet Away · Charging Time Approximately 3 Hours
- Play Time At Full Volume And Full Charge Approximately 5 Hours





TYPE-C

#252912



TYPE-C

#25722



#25250



Phone Not Included

**#252912 SOUND ASLEEP WHITE NOISE MACHINE & SPEAKER 2.0**

- Now With A Type-C Input (Cord Included)
- Includes 6 Soothing Sounds - Bird Chirps, Rainy Day, Fireside, White Noise, Ocean Waves And Windy Breeze
- Features Time Span Options Or Continuous Play (Instructions Included)
- Wireless Speaker Featuring High Definition Bluetooth® 5.3 Technology
- Simply Pair With Your Device To Enjoy Dynamic Stereo Sound
- LED Indicator Lights · 300 mAh Lithium Polymer Battery
- Pairs From Up To 30 Feet Away
- Up To 2 Hours Of Play Time

**#25722 MIGHTY MINI WIRELESS SPEAKER 2.0**

- Now With A Type-C Input (Cord Included)
- Wireless Speaker Featuring High Definition Bluetooth® 4.2 Technology
- Simply Pair Your Device With The Speaker To Enjoy Dynamic Stereo Sound
- Loop For Carrying
- LED Indicator Light
- 200 mAh Polymer Lithium Ion Battery
- Up To 1 1/2 Hours Of Play Time
- Perfect For Your Home, Office Or Outdoor Activities

**#25250 RISE & SHINE CLOCK WITH LIGHT-UP SPEAKER & CHARGER**

- Charge Qi Enabled Devices Wirelessly By Placing Compatible Device On Top Of Charging Pad
- Features High Definition Bluetooth® 5.3 Wireless Technology
- Simply Pair With Your Device To Enjoy Dynamic Stereo Sound
- Multi-Color LED Party Lights With 13 Different Settings
- Digital Display With 12-Hour Clock Settings · White Noise Alarm Clock
- 6 Soothing Sounds To Choose From - Brook Noise, White Noise, Ocean Wave, Rainy Day, Wind & Fireside
- Push Button To Power On/Off And Choose Settings
- Features A Type-C Input (Cord Included) · 1200 mAh Lithium Ion Grade Battery Included
- Wireless Output Up To 10W
- Pairs From Up To 32 Feet Away · Charging Time Approximately 2 Hours

TYPE-C



#29062 Multi-Color LED Lights Change Color When In Use

#29062 OCTAVE LIGHT UP WIRELESS SPEAKER 2.0

- Now With A Type-C Input (Cord Included)
- Wireless Speaker Featuring High Definition Bluetooth® 4.2 Technology
- Simply Pair Your Device To Enjoy Dynamic Stereo Sound
- Multi-Color LED Lights Change Color When In Use
- Wrist Strap · Non-Slip Bottom · 200 mAh Lithium Polymer Battery
- Pairs From Up To 30 Feet Away · Up To 2 Hours Of Play Time
- Perfect For Your Home, Office Or Outdoor Activities

#25249 PARTY VIBE LIGHT-UP SPEAKER

- Features High Definition Bluetooth® 5.3 Wireless Technology
- Simply Pair With Your Device To Enjoy Dynamic Stereo Sound
- Water-Resistant · Multi-Color LED Lights Illuminate When In Use
- Press Button To Power On/Off And Change Light Settings
- Pull-Out Loop For Carrying · Features A Type-C Input (Cord Included)
- 1200 mAh Lithium Ion Grade A Battery · Pairs From Up To 33 Feet Away
- Play Time At Full Volume And Full Charge Approximately 5 Hours
- Charging Time Approximately 2 Hours

#25171 LOUD & CLEAR WIRELESS SPEAKER

- Wireless Speaker Featuring High Definition Bluetooth® 5.3 Technology
- Simply Pair With Your Device To Enjoy Dynamic Stereo Sound
- Push Buttons To Turn On/Off And Change Light Settings
- Multi-Color LED Lights Illuminate When In Use
- Loop For Carrying
- 500 mAh Lithium Polymer Battery
- Features A Type-C Input (Cord Included)
- Pairs From Up To 33 Feet Away
- Up To 2 1/2 Hours Of Play Time
- Perfect For Your Home, Office Or Outdoor Activities

TYPE-C



#25249



Back

#25171

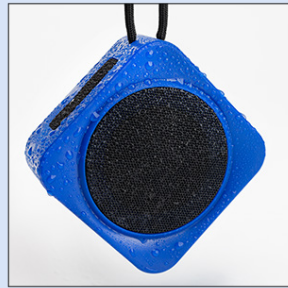

Water-Resistant



#25241 ROCKIN' RABS SPEAKER

- Made Of Recycled rABS
- Recycled ABS (Acrylonitrile Butadiene Styrene) Is Obtained By Melting Down Post Consumer ABS Plastic To Create New ABS Plastic.
- Wireless Speaker Featuring High Definition Bluetooth® 5.0 Technology
- Simply Pair With Your Device To Enjoy Dynamic Stereo Sound Or Receive Hands-Free Calls
- Hands-Free Design · Loop For Carrying
- Press Buttons To Power On/Off, Play/Pause And Answer/End Calls
- Water-Resistant · TF Card Slot
- TWS (True Wireless Sound) Allows Connection To 2 Speakers At Once For Surround Sound
- 800 mAh Lithium Polymer Battery · Features A Type-C Input (Cord Included)
- Pairs From Up To 32 Feet Away · Up To 4 Hours Of Play Time
- Instructions Included



#25209 GLOW UP SPEAKER

- Wireless Speaker Featuring High Definition Bluetooth® 5.3 Technology
- Simply Pair With Your Device To Enjoy Dynamic Stereo Sound
- Push Buttons To Turn On/Off And Change Light Settings
- Multi-Color LED Lights Illuminate When In Use
- Aux Port
- 1200 mAh Lithium Polymer Battery
- Features A Type-C Input (Cord Included)
- Pairs From Up To 33 Feet Away
- Up To 2 1/2 Hours Of Play Time
- Perfect For Your Home, Office Or Outdoor Activities



Phone Not Included



#25992 COLISEUM WIRELESS CHARGER 2.0

- Now With A Type-C Input (Cord Included)
- Wireless Speaker Featuring High Definition Bluetooth® 3.0 Technology
- Simply Pair Your Device To Enjoy Dynamic Stereo Sound
- Holds A Variety Of Phone Sizes For Easy Viewing
- 200 mAh Lithium Polymer Battery Included
- Pairs From Up To 30 Feet Away
- Up To 1 Hour Of Play Time



#25207



Lights Off



Additional Light Colors



#267792

**#25207 BOOMIN' SOUNDBAR SPEAKER**

- Wireless Speaker Featuring High Definition Bluetooth® 5.31 Technology
- Simply Pair With Your Device To Enjoy Dynamic Stereo Sound
- Multi-Color LED Lights Illuminate Grille When In Use
- Push Buttons To Turn On/Off And Change Settings
- FM Mode Scans For Radio Stations
- MicroSD Card Slot
- Aux Port
- 1200 mAh Lithium Ion Grade A Battery
- Features A Type-C Input (Cord Included)
- Pairs From Up To 33 Feet Away
- Up To 2 Hours Of Play Time

**#267792 WATERPROOF SPEAKER TOWER 2.0**

- Now With A Type-C Input (Cord Included)
- Wireless Speaker Featuring High Definition Bluetooth® 5.0 Technology
- Simply Pair With Your Device To Enjoy Dynamic Stereo Sound
- 1200 mAh Lithium Polymer Battery
- Pairs From Up To 30 Feet Away
- Up To 4 Hours Of Play Time

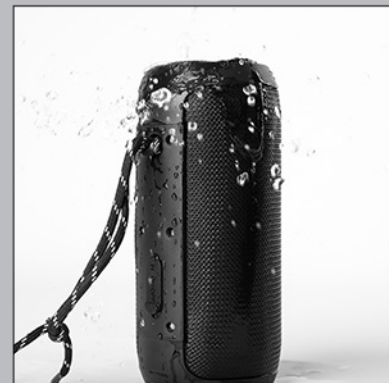





**#25218 WALL MOUNT WIRELESS SPEAKER**

- Features High Definition Bluetooth® 5.3 Wireless Technology
- Simply Pair With Your Device To Enjoy Dynamic Stereo Sound Or Receive Hands-Free Calls
- Hands-Free Design · Mount To Wall With Screws & Adhesive Tape (Included)
- TF Card Slot, Aux Port And FM Radio Function
- Press Buttons To Power On/Off, Play/Pause And Answer/End Calls
- Features A USB-A Output And Type-C Input (Cord Included) · 1200 mAh Lithium Ion Grade A Battery
- Pairs From Up To 33 Feet Away · Charging Time 3-4 Hours
- Up To 6 Hours Of Play Time At 100% Volume, 20 Hours At 50% Volume · Instructions Included
- The Bluetooth® word mark and logos are registered trademarks owned by the Bluetooth SIG, Inc. and any use of such marks by Hit Promotional Products, Inc. is under license. Other trademarks and trade names are those of their respective owners.



TYPE-C

**#25196 MAGIC MIC KARAOKE SET**

- Set Includes 1 Mini Karaoke Speaker With Handle And 2 Mini Microphones
- Wireless Speaker Featuring High Definition Bluetooth® 5.3 Technology
- Simply Pair Your Device To Enjoy Dynamic Stereo Sound
- Microphones Feature 3 Voice Settings - High, Middle & Low
- Push Buttons To Turn On/Off And Change Settings
- Multi-Color LED Lights
- Aux Port
- 1200 mAh Lithium Polymer Speaker Battery, 300 mAh Lithium Polymer Microphone Battery
- Features A Type-C Input (Cord Included)
- Pairs From Up To 50 Feet Away
- Up To 2 Hours Of Play Time
- Instructions Included



Standard Imrpint Area



Front



Back  
Optional Imrpint Area

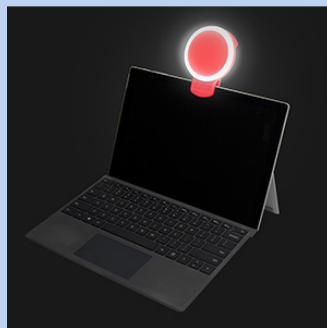

**#25192 REACH RETRACTABLE RING LIGHT**

- Retractable Cord Plugs Into Your Device For Lighting On The Go
- Features Cool & Warm Light Settings With 3 Levels Of Brightness - Low, Medium & High
- Perfect For Zoom Meetings, Photos & Videos
- Clips On To Most Devices
- Slide Webcam Cover To Open/Close
- Compatible With USB-A & Type-C Devices



Phone not included

#25243 DASHBOARD PHONE HOLDER

- Made Of Silicone
- Anti-Slip Surface Adheres To Your Dashboard
- Easily Removable
- Holds Devices, Sunglasses, Etc.
- Holds A Variety Of Phone Sizes For Easy Viewing
- Easy To Clean

#25195 GADGET GRIP PHONE STAND & CORD WRAP

- Made Of Silicone
- Adheres To Back Of Your Phone With Strong Adhesive
- Wrap Cords Around To Stay Tangle Free
- Makes Holding And Handling Smartphone Easier



Cord Not Included



Phone Not Included



Phone Not Included



#25242 MAGNETIC PHONE HOLDER GRIP

- Convenient Phone Ring That Doubles As A Stand
- Adheres To Back Of Your Phone Magnetically
- Makes Holding And Handling Smartphone Easier
- Compatible With Magnetic Phones
- Ring Included For Non-Magnetic Phones



#25197



Laptop And Mouse Not Included



#23559

Phone And Cards Not Included



#25229

**#25197 STICK & STORE MOUSE POUCH**

- Made Of Lycra And Microfiber
- Adheres To Laptops And Tablets With Strong Adhesive
- Store & Carry Wireless Mouse In Adhesive Pouch
- Suitable For A Variety Of Wireless Mice

**#23559 MAGNETIC PHONE WALLET AND STAND**

- Made Of Durable Manganese Steel
- Convenient Phone Wallet That Doubles As A Vertical Or Horizontal Stand
- Magnetic Snap Closure
- Adheres To Back Of Your Phone With Self-Adhesive Metal Ring
- Holds Up To 3 Cards
- Perfect For Carrying Identification, Room Key, Cash Or Credit Card

**#25229 MAGNETIC STRETCH PHONE WALLET**

- Made Of Lycra · Compatible With Magnetic Phones
- Adheres To Back Of Your Phone With Built-In Magnets
- Holds Up To 8 Cards
- Perfect For Carrying Identification, Room Key, Cash Or Credit Card



Phone And Cards  
Not Included



#25227 SILICONE MAGNETIC PHONE WALLET

- Silicone Material · Compatible With Magnetic Phones
- Adheres To Back Of Your Phone Magnetically
- Ring Included For Non-Magnetic Phones
- 2 Card Slots · Holds Up To 3 Cards
- Perfect For Carrying Identification, Room Key, Cash Or Credit Card

Phone And Cards  
Not Included



#25212 MAGNETIC PHONE WALLET

- Made Of Polyurethane
- Compatible With Magnetic Phones
- Adheres To Back Of Your Phone With 22 Built-In Magnets For Added Stability
- Holds Up To 3 Cards
- Perfect For Carrying Identification, Room Key, Cash Or Credit Card



Contents Not Included

**#25266 RPET TECH POUCH WITH CORD PASS THROUGH**

- Made Of 600D Laminated rPET Material · 210D rPET PU Lining
- Made From Post Consumer Recycled Materials
- Recycled Polyester (rPET) Is Obtained By Melting Down Existing Plastic Bottles And Other Material Sources To Create New Polyester Fiber
- Inside Lining, Inside Foam, Binding, Zipper And Label Are Not rPET
- Zippered Main Compartment · Front Zippered Pocket
- Silicone Pass Through Allows Cord Access From The Front Pocket
- Interior Pockets And Elastic Straps For Organization
- Carrying Handle · Spot Clean/Air Dry



Contents Not Included



**#30141 HUDSON RECYCLED LEATHERETTE TECH ORGANIZER**

- Made Of Combo: 85% rPET Foggy PU & 210D Polyester
- 3MM PE Foam Lining · Made From Post Consumer Recycled Materials
- Recycled Polyester (rPET) Is Obtained By Melting Down Existing Plastic Bottles And Other Material Sources To Create New Polyester Fiber
- Lining, Handle, Mesh, Elastic Straps, Zippers & Pulls Are Not rPET
- Zippered Main Compartment · Front Slip Pocket
- Interior Pockets And Elastic Straps For Organization
- Handle For Easy Carrying · Spot Clean/Air Dry



Items Not Included



**#25239 PUSH POP PHONE TETHER WRISTLET**

- Made Of Silicone & Polyester · Fun Stress Reliever · Tether Patch Included
- Features Swivel J-Hook For Attaching Keys, Tether Patch, Etc.
- Press Bubbles Down To Relieve Stress
- Make Your Own Pattern By Pressing On Different Bubbles Or Just Press For Fun
- Tether Patch Fits Inside Phone Case And Attaches To Wristlet
- Encourages Focus And Self-Soothing For Users With Anxiety, Attention Disorders And More
- Perfect For Reducing Stress And Boredom

# DESK ACCESSORIES



## #65049 TAYLOR PADFOLIO WITH STICKY NOTES & FLAGS

- 80 Page Lined Note Pad · Polyurethane Cover · Sticky Notes In Various Colors And Shapes
- Sticky Flags In 5 Neon Colors · Matching Magnetic Strap Closure And Plunger Action Pen
- Supports Responsible Forestry · FSC® Certified
- FSC® Certified Products Are Made With, Or Contain, Forest-Based Materials Sourced From Forests That Have Been Audited By An Independent Third Party To Confirm They Are Managed According To FSC®'s Rigorous Social And Environmental Standards.



## #65048 OWEN BAMBOO JOURNAL

- 100 Page Lined Journal · Bamboo Cover · Strap Closure And Elastic Pen Loop
- Supports Responsible Forestry · FSC® Certified
- FSC® Certified Products Are Made With, Or Contain, Forest-Based Materials Sourced From Forests That Have Been Audited By An Independent Third Party To Confirm They Are Managed According To FSC®'s Rigorous Social And Environmental Standards.



Phone Not Included

## #55240 BAMBOO DESK JOTTER WITH PHONE STAND

- 70 Page Unlined Notebook · Sticky Flags In 6 Neon Colors
- Matching Pen Has Paper Barrel In Elastic Pen Loop · Cover Doubles As Phone Stand
- Holds A Variety Of Phone Sizes For Easy Viewing · Supports Responsible Forestry
- FSC® Certified
- FSC® Certified Products Are Made With, Or Contain, Forest-Based Materials Sourced From Forests That Have Been Audited By An Independent Third Party To Confirm They Are Managed According To FSC®'s Rigorous Social And Environmental Standards.



## #65044 BAMBOO LOOK JOTTER & PEN

- 80 Page Lined Notebook · Bamboo Look Polyurethane Cover
- Matching Bamboo Pen In Elastic Pen Loop
- Supports Responsible Forestry · FSC® Certified
- FSC® Certified Products Are Made With, Or Contain, Forest-Based Materials Sourced From Forests That Have Been Audited By An Independent Third Party To Confirm They Are Managed According To FSC®'s Rigorous Social And Environmental Standards.



UPCYCLE

#### #65027 TREE-FREE LEMONGRASS JOURNAL

- 20 Page Lined Upcycled Journal
- Cover Made From Upcycled Lemongrass
- Lemongrass Is A Water Reducing Upcycled Material



UPCYCLE

#### #65026 NEW BREW COFFEE HUSK JOURNAL

- 50 Page Lined Upcycled Journal
- Cover Made From Upcycled Coffee Husk
- Biobased Tree Free Cotton Pages



FSC  
www.fsc.org  
FSC® C190385

#### #65047 VENTURE JOURNAL

- 80 Page Lined Journal · Matching Pen Loop
- Supports Responsible Forestry · FSC® Certified
- FSC® Certified Products Are Made With, Or Contain, Forest-Based Materials Sourced From Forests That Have Been Audited By An Independent Third Party To Confirm They Are Managed According To FSC®'s Rigorous Social And Environmental Standards.

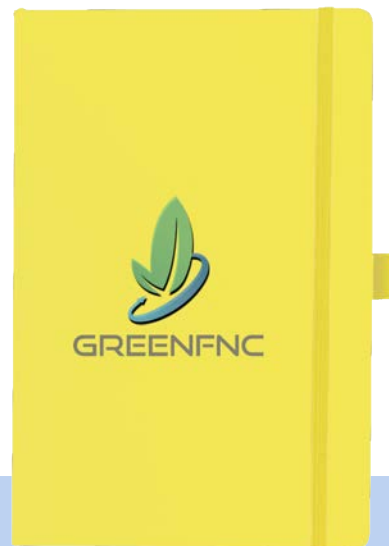

FSC  
www.fsc.org  
FSC® C190385

#### #65043 HARPER PULP JOURNAL

- 80 Page Lined Journal · Cover Made From Pulp · Cardboard Backcover
- Matching Bookmark, Strap Closure And Elastic Pen Loop
- Supports Responsible Forestry · FSC® Certified
- FSC® Certified Products Are Made With, Or Contain, Forest-Based Materials Sourced From Forests That Have Been Audited By An Independent Third Party To Confirm They Are Managed According To FSC®'s Rigorous Social And Environmental Standards.



FSC  
www.fsc.org  
FSC® C190385

#### #65035 APPLE SKIN JOURNAL

- 100 Page Lined Notebook
- Cover Made From Upcycled Apple Skin And Polyurethane
- Matching Bookmark, Strap Closure And Elastic Pen Loop
- Interior Pocket · Supports Responsible Forestry · FSC® Certified
- FSC® Certified Products Are Made With, Or Contain, Forest-Based Materials Sourced From Forests That Have Been Audited By An Independent Third Party To Confirm They Are Managed According To FSC®'s Rigorous Social And Environmental Standards.

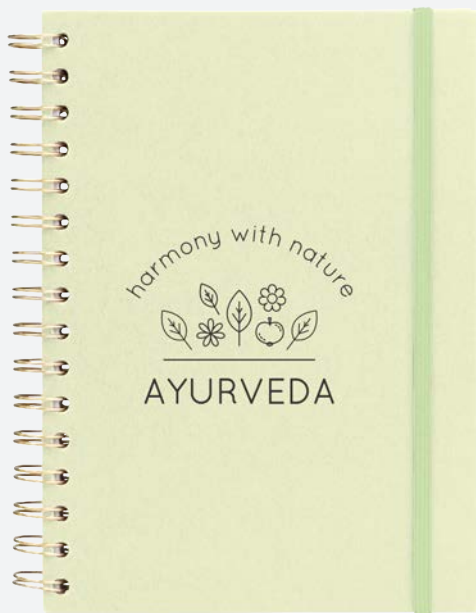

#65036 FRUIT PAPER SPIRAL NOTEBOOK

- 100 Page Lined Notebook
- Cover Made From Fruit Paper
- Matching Strap Closure
- Interior Pocket



#65029 ROCHESTER RECYCLED LEATHER JOURNAL

- 80 Page Lined Journal
- Recycled Leather Soft Cover
- Matching Pen Loop
- Front Slot For Business Cards
- Refillable



The mark of responsible forestry

#65050 REPREEVE® RECYCLED SPIRAL NOTEBOOK WITH PEN

- 80 Page Lined Notebook · Cover And Pen Barrel Are Made Of Recycled PP
- Matching Strap Closure And Elastic Pen Loop With Matching Pen · Plunger Action Pen
- REPREEVE® Is The Global Leader In Recycled Performance Fibers. They Have Transformed Billions Of Recycled Materials Into More Sustainable Polyester Using Cutting-Edge Textile Technology.
- REPREEVE® Our Ocean™ Is A Premium Collection Of Fiber And Resin Sourced From Materials At High Risk Of Entering The Ocean.
- REPREEVE® Keeps Materials Out Of Landfills And Oceans, Conserves Electricity And Water And Reduces Greenhouse Emissions And Petroleum Use.
- Supports Responsible Forestry · FSC® Certified
- FSC® Certified Products Are Made With, Or Contain, Forest-Based Materials Sourced From Forests That Have Been Audited By An Independent Third Party To Confirm They Are Managed According To FSC®'s Rigorous Social And Environmental Standards.



The mark of responsible forestry

#65046 OLIVIA RPET JOURNAL

- 80 Page Lined Journal · Cover Made From Post Consumer Recycled Materials
- Recycled Polyester (rPET) is Obtained By Melting Down Existing Plastic Bottles And Other Material Sources To Create New Polyester Fiber
- Binding Board and Inside Pages Are Not rPET
- Bookmark · Supports Responsible Forestry · FSC® Certified
- FSC® Certified Products Are Made With, Or Contain, Forest-Based Materials Sourced From Forests That Have Been Audited By An Independent Third Party To Confirm They Are Managed According To FSC®'s Rigorous Social And Environmental Standards.





The mark of responsible forestry

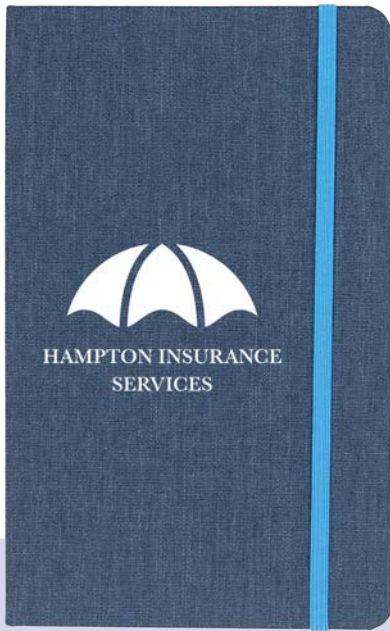

Phone & Pen Not Included



The mark of responsible forestry

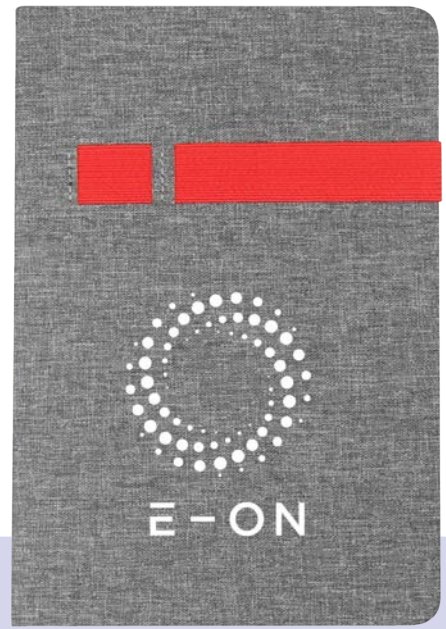

### #65032 EUGENE RPET JOURNAL

- 96 Page Lined Notebook
- Fabric Cover Made From Post Consumer Recycled Materials
- Recycled Polyester (rPET) is Obtained By Melting Down Existing Plastic Bottles And Other Material Sources To Create New Polyester Fiber
- Binding Board and Inside Pages Are Not rPET
- Matching Bookmark And Strap Closure
- Supports Responsible Forestry · FSC® Certified
- FSC® Certified Products Are Made With, Or Contain, Forest-Based Materials Sourced From Forests That Have Been Audited By An Independent Third Party To Confirm They Are Managed According To FSC®'s Rigorous Social And Environmental Standards.

### #65042 SCHOLAR RPET JOURNAL

- 80 Page Lined Notebook
- Cover Made From Post Consumer Recycled Materials
- Recycled Polyester (rPET) is Obtained By Melting Down Existing Plastic Bottles And Other Material Sources To Create New Polyester Fiber
- Binding Board and Inside Pages Are Not rPET · Elastic Band To Hold Pen Or Phone
- Supports Responsible Forestry · FSC® Certified
- FSC® Certified Products Are Made With, Or Contain, Forest-Based Materials Sourced From Forests That Have Been Audited By An Independent Third Party To Confirm They Are Managed According To FSC®'s Rigorous Social And Environmental Standards.



The mark of responsible forestry



The mark of responsible forestry

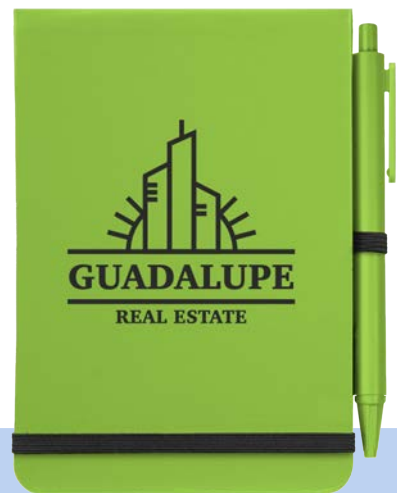

### #65040 BOOK CLUB RPET FELT NOTEBOOK

- 80 Page Notebook · Felt Cover Made From Post Consumer Recycled Materials
- Recycled Polyester (rPET) is Obtained By Melting Down Existing Plastic Bottles And Other Material Sources To Create New Polyester Fiber
- Inner Sheets, Pen Loop and Bookmark Are Not rPET
- Bookmark And Elastic Pen Loop FSC® Certified · Supports Responsible Forestry
- FSC® Certified Products Are Made With, Or Contain, Forest-Based Materials Sourced From Forests That Have Been Audited By An Independent Third Party To Confirm They Are Managed According To FSC®'s Rigorous Social And Environmental Standards.

### #65041 REFLECTIONS JOTTER WITH MIRROR & PEN

- 80 Page Lined Notepad · Elastic Strap Closure
- Polypropylene Cover · Matching Pen In Elastic Pen Loop
- Mirror On Inside Cover · Supports Responsible Forestry · FSC® Certified
- FSC® Certified Products Are Made With, Or Contain, Forest-Based Materials Sourced From Forests That Have Been Audited By An Independent Third Party To Confirm They Are Managed According To FSC®'s Rigorous Social And Environmental Standards.



#10204



#55244



**MEGA  
BRITE**

**#10204 GAMING PAD**

- Face Side Made Of 3MM Microfiber/Micro-Weave
- Large Mouse Pad For Gamers, Keyboards, Office And Home
- Stitched Edges
- Non-Slip Black Base On Bottom

**#55244 FULL COLOR RPET DESK MAT**

- Made From Post Consumer Recycled Materials
- Recycled Polyester (rPET) is Obtained By Melting Down Existing Plastic Bottles And Creating New Polyester Fiber
- Non-Slip Bottom Is Not rPet
- Protects Desk Top From Scuffs & Scratches
- Use As A Mouse Pad
- Large Desk Coverage
- Rubber Non-Slip Bottom



Items Not Included



**#55246 -4 COMPARTMENT PEN & PENCIL CUP**  
 · Supports Responsible Forestry · FSC® Certified  
 · FSC® Certified Products Are Made With, Or Contain, Forest-Based Materials Sourced From Forests That Have Been Audited By An Independent Third Party To Confirm They Are Managed According To FSC®'s Rigorous Social And Environmental Standards.



Items Not Included



**#55239 BAMBOO LAPTOP DESK**  
 · Made Of Bamboo And Polyester  
 · Built-In Device Ledge Keeps Laptop From Slipping  
 · Mouse Pad  
 · Phone And Tablet Slot Keeps Phone And Tablet Handy  
 · Bolster Cushion



**#55243 MAGNETIC CLIP**  
 · Spring-Loaded Hinge  
 · Made Of Recycled Polystyrene With Top Bamboo Grip  
 · Large Imprint Area · Magnet On Back Side  
 · Supports Responsible Forestry · FSC® Certified  
 · FSC® Certified Products Are Made With, Or Contain, Forest-Based Materials Sourced From Forests That Have Been Audited By An Independent Third Party To Confirm They Are Managed According To FSC®'s Rigorous Social And Environmental Standards.



**#55247 MAGNETIC CLIP WITH BAMBOO ACCENT**  
 · Spring-Loaded Hinge · Large Imprint Area  
 · Magnet On Back Side · FSC® Certified  
 · Supports Responsible Forestry  
 · FSC® Certified Products Are Made With, Or Contain, Forest-Based Materials Sourced From Forests That Have Been Audited By An Independent Third Party To Confirm They Are Managed According To FSC®'s Rigorous Social And Environmental Standards.

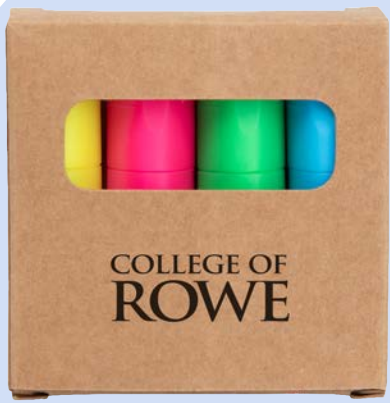

#11985 - 4-IN-1 MINI HIGHLIGHTER SET  
 · 4 Chisel Tip Highlighters  
 · Highlighter Colors Include Blue, Green, Pink And Yellow



#12004 QUAD 4-IN-1 HIGHLIGHTER  
 · Chisel Tip Highlighters  
 · Dual End Highlighters With Two Colors On Each Side  
 · Highlighter Colors Include Blue, Green, Orange And Yellow

#11987 FIDGET HIGHLIGHTER

- Chisel Tip
- Fidget Roller Ball On End
- Perfect For Reducing Stress And Boredom
- Encourages Focus And Self-Soothing For Users With Anxiety, Attention Disorders And More



#12009 RPET HIGHLIGHTER  
 · Chisel Tip Highlighter  
 · Cap And Barrel Made Of rPET  
 · Made From Post Consumer Recycled Materials  
 · Recycled Polyester (rPET) is Obtained By Melting Down Existing Plastic Bottles And Other Material Sources To Create New Polyester Fiber





#11998 - 12-PIECE COLORED PENCIL SET  
 · Pencil Colors Included: Black, Blue, Brown, Burgundy, Dark Green, Green, Orange, Pink, Purple, Red or Yellow.



#12007 LUCA PENCIL  
 · Bonded Core #2 Pencil  
 · Wood-Cased Barrel With A Black-Colored Ferrule And A Colorful Eraser



#11996 INFINITY BAMBOO PENCIL  
 · Removable Cap  
 · Eraser On Top  
 · Perfect For Artists  
 · No Sharpening Or Refills Required



**#11997 A-MAZE ME PEN**

- Plunger Action · Maze Ball Game
- Pass The Maze Ball From One End Of The Pen To The Other
- Perfect For Reducing Stress And Boredom
- Encourages Focus And Self-Soothing For Users With Anxiety, Attention Disorders And More



**#11999 ROLL & WRITE FIDGET PEN**

- Twist Action · Fidget Roller Ball On Top
- Unique Grip Design
- Perfect For Reducing Stress And Boredom
- Encourages Focus And Self-Soothing For Users With Anxiety, Attention Disorders And More



**#12001 RECYCLED ALUMINUM SPINNER PEN WITH STYLUS**

- Twist Action
- Pen Barrel Is Made of Recycled Aluminum
- Stylus On Top
- Fidget Spinner Accent
- Perfect For Reducing Stress And Boredom
- Encourages Focus And Self-Soothing For Users With Anxiety, Attention Disorders And More



**#12002 ZINNIA RUBBERIZED PEN WITH STYLUS**

- Plunger Action
- Smooth Rubberized Finish
- Push Down To Use Pen And Retract To Use Stylus



**#29007 WAVE PEN**

- Plunger Action
- Unique Grip Design



**#12003 AURORA RECYCLED GEL PEN**

- Plunger Action
- Made of rABS
- Recycled ABS (Acrylonitrile Butadiene Styrene) Is Obtained By Melting Down Post Consumer ABS Plastic To Create New ABS Plastic





**#12010 LINCOLN RABS PEN**  
 · Plunger Action · Made Of rABS  
 · Recycled ABS (Acrylonitrile Butadiene Styrene) Is Obtained By Melting Down Post Consumer ABS Plastic To Create New ABS Plastic



**#12008 NOVA RABS PEN**  
 · Plunger Action · Made of rABS  
 · Recycled ABS (Acrylonitrile Butadiene Styrene) Is Obtained By Melting Down Post Consumer ABS Plastic To Create New ABS Plastic



**#12005 SAWYER PEN**  
 · Plunger Action  
 · Rubber Grip For Writing Comfort And Control



**#12006 JAXON RABS PEN**  
 · Plunger Action · Made Of rABS  
 · Recycled ABS (Acrylonitrile Butadiene Styrene) Is Obtained By Melting Down Post Consumer ABS Plastic To Create New ABS Plastic  
 · Unique Grip Design For Comfort Grip For Writing Comfort And Control



**#12014 MAVRICK RECYCLED ALUMINUM PEN**  
 · Plunger Action  
 · Pen Barrel Is Made of Recycled Aluminum



**#11995 RECYCLED ALUMINUM SPIN GAME TOP PEN WITH STYLUS**  
 · Plunger Action  
 · Made Of Recycled Aluminum  
 · Stylus On Top · Spin Game Top  
 · Perfect For Reducing Stress And Boredom  
 · Encourages Focus And Self-Soothing For Users With Anxiety, Attention Disorders And More



#12012 HARPER BAMBOO GEL PEN  
 · Removable Cap  
 · Unique Grip Design



#11994 TROPICAL BAMBOO  
 INCLINE PEN WITH STYLUS  
 · Plunger Action  
 · Stylus On Top



#12011 ANDERSON SLEEK  
 WRITE BAMBOO PEN  
 · Plunger Action  
 · Sleek Write Low Viscosity Ink



#11992 ECO-INSPIRED PEN WITH COLOR BARREL  
 · Plunger Action  
 · Paper Barrel With Wooden Clip



#12015 HAYDEN RABS PEN  
 · Plunger Action  
 · Made Of rABS With Bamboo Plunger  
 · Recycled ABS (Acrylonitrile Butadiene Styrene)  
 Is Obtained By Melting Down Post Consumer  
 ABS Plastic To Create New ABS Plastic



#12013 ASHER RECYCLED ALUMINUM PEN  
 · Plunger Action  
 · Pen Barrel Is Made Of Recycled Aluminum  
 · Plunger Made Of Bamboo  
 · Unique Grip Design



# FOOD GIFTS

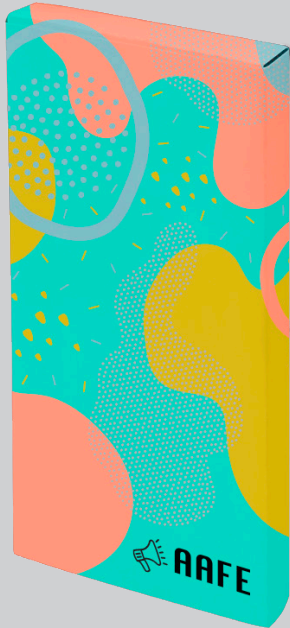

#CHOCBARCARDBOX

Cookie Dough



Everything You Love

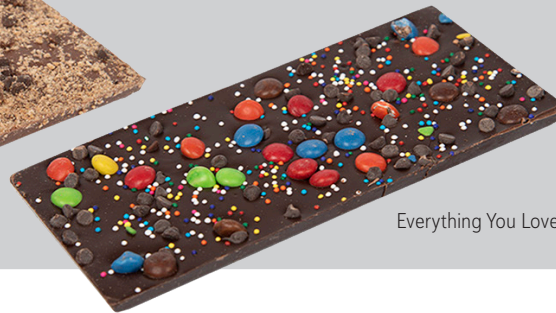

#IWM-FRUITSOURS

**MEGA  
BRITE**



Yellow Sour



Red Sour



Orange Sour

Orders will receive a mix of these flavors

#CHOCBARCARDBOX GOURMET CHOCOLATE BAR IN CARD BOX

- 3.5 Oz. Chocolate Bar Available In Two Gourmet Flavors
- Card Gift Box Included
- 14 Pt. Cardstock

#IWM-FRUITSOURS INDIVIDUALLY WRAPPED FRUIT SOUR BUTTERMINTS

- Individually Wrapped Fruit Sour Flavored Buttermints
- Full Color Magazine Quality Wrapper
- Optional Canister Available

# GIFT SETS & KITS

## #55278 INTREPID TRIO KIT

- Set Includes #50035 - 40 Oz. Intrepid Stainless Steel Tumbler, #5276 Straw Topper For 40 Oz. Intrepid Tumblers And #30107 Intrepid Water Bottle Pouch
- Pricing Includes 1 Color/1 Location Imprint On Each Item. Includes Mailer Box, Crinkle Stuffing, Insert Card, Box Label and Kitting.
- Create Your Own Message With The Included Insert Card. Add Your Own Design or Choose From Any Stock Design. Optional Stock Design Shown



## #55277 INTREPID SNACK AND GO KIT

- Kit Includes #50035 - 40 Oz. Intrepid Stainless Steel Tumbler, #5276 Straw Topper For 40 Oz. Intrepid Tumblers, #75056 Intrepid Tumbler Snack Bowl And #30107 Intrepid Water Bottle Pouch
- Pricing Includes 1 Color/1 Location Imprint On Each Item. Includes Mailer Box, Crinkle Stuffing, Insert Card, Box Label and Kitting.
- Create Your Own Message With The Included Insert Card. Add Your Own Design or Choose From Any Stock Design. Optional Stock Design Shown
- Card Stock Design Shown: Thank You #000132



## #99918 INTREPID SNACK SET

- Set Includes #50035 - 40 Oz. Intrepid Stainless Steel Tumbler And #75056 Intrepid Tumbler Snack Bowl
- Pricing Includes 1 Color/1 Location Imprint On Each Item. Includes Mailer Box, Crinkle Stuffing, Insert Card, Box Label and Kitting.
- Create Your Own Message With The Included Insert Card. Add Your Own Design or Choose From Any Stock Design. Optional Stock Design Shown.
- Card Stock Design Shown: Thank You #000133



#95228



#96302

**#95228 INTREPID TRAVELER SET**

- Set Includes #50035 - 40 Oz. Intrepid Stainless Steel Tumbler And #30107 Intrepid Water Bottle Pouch
- Pricing Includes 1 Color/1 Location Imprint on Each Item. Includes Mailer Box, Crinkle Stuffing, Insert Card, Box Label and Kitting.
- Create Your Own Message With The Included Insert Card. Add Your Own Design or Choose From Any Stock Design. Optional Stock Design Shown.
- Card Stock Design Shown: Thank You #000125

**#96302 INTREPID SNACK BUZZ KIT**

- Kit Includes #75056 Intrepid Tumbler Snack Bowl, #50035 - 40 Oz. Intrepid Stainless Steel Tumbler, #ZSW5 Zagasnacks™ Wide Promo Pack Bag With Mixed Nuts, Gummy Bears, #ZSW6 Zagasnacks™ Wide Promo Pack Bag With Famous Amos® Chocolate Chip Cookies And #GPS Gourmet Popcorn Single
- Pricing Includes 1 Color/1 Location Imprint On #75056 Intrepid Tumbler Snack Bowl, #50035 - 40 Oz. Intrepid Stainless Steel Tumbler, #ZSW5 Zagasnacks™ Wide Promo Pack Bag, #ZSW6 Zagasnacks™ Wide Promo Pack Bag, #GPS Gourmet Popcorn Single Sold As Shown. Includes Mailer Box, Crinkle Stuffing, Insert Card, Box Label and Kitting.
- Create Your Own Message With The Included Insert Card. Add Your Own Design or Choose From Any Stock Design. Optional Stock Design Shown.
- Card Stock Design Shown: Thank You #000125



Optional  
Deboss on Box

Optional Drink Mix Packets



#95006 MOSCOW MULE COCKTAIL KIT

- Set Includes 2 #5751 - 14 Oz. Moscow Mule Barrel Mugs, #2142 Stainless Steel Ice Cubes In Case, And 2 #2002 Bonded Leather Coasters
- Pricing Includes 1-Color Imprint In 1-Location Each Item. Includes Choice Of Stock Design Or Use Your Own Custom Art On Included Card.
- Create Your Own Message With The Included Insert Card. Add Your Own Design Or Choose From Any Stock Design. Optional Stock Design Shown.
- Card Stock Design Shown: Cocktail Recipes #000129



#75078 PERFECT POUR & STORE WINE KIT

- Kit Includes #2101 Electric Wine Opener, Wine Purer And Wine Stopper · Price Includes 1-Color/1-Location Imprint On #2101 Electric Wine Opener, Wine Purer And Wine Stopper Sold As Shown



#96223 MALIBU SUNGLASSES WITH RPET MICROFIBER SUNGLASS POUCH  
 · Kit Includes: #86243 rPET Microfiber Sunglass Pouch And #6223 Malibu Sunglasses  
 · Pricing Includes 1-Color Imprint In 1-Location On #6223 Malibu Sunglasses And 4-Color Process Imprint On #86243 rPET Microfiber Sunglass Pouch



#96298 GATSBY RECYCLED FRAME SUNGLASSES RPET MICROFIBER SUNGLASS POUCH  
 · Kit Includes: #6298 Gatsby Recycled Frame Sunglasses And #86243 rPET Microfiber Sunglass Pouch  
 · Pricing Includes 1-Color Imprint In 1-Location On #6298 Gatsby Recycled Frame Sunglasses And 4-Color Process Imprint On #86243 rPET Microfiber Sunglass Pouch



#94000 RUBBERIZED SUNGLASSES WITH RPET MICROFIBER SUNGLASS POUCH  
 · Kit Includes: #86243 rPET Microfiber Sunglass Pouch And #4000 Rubberized Sunglasses  
 · Pricing Includes 1-Color Imprint In 1-Location On #4000 Rubberized Sunglasses And 4-Color Process Imprint On #86243 rPET Microfiber Sunglass Pouch



#98245 AVIATOR SUNGLASSES WITH RPET MICROFIBER SUNGLASS POUCH  
 · Kit Includes: #86243 rPET Microfiber Sunglass Pouch And #8245 Aviator Sunglasses With Mirrored Lenses  
 · Pricing Includes 1-Color Imprint In 1-Location On #8245 Aviator Sunglasses With Mirrored Lenses And 4-Color Process Imprint On #86243 rPET Microfiber Sunglass Pouch



#86243 RPET MICROFIBER SUNGLASS POUCH  
 · Made From Post Consumer Recycled Materials  
 · Recycled Polyester (rPET) is Obtained By Melting Down Existing Plastic Bottles And Other Material Sources To Create New Polyester Fiber  
 · Can Also Be Used For Sunglass Cleaning  
 · Spot Clean/Air Dry



**#95292 OUTDOOR ESSENTIALS KIT**

- Kit Includes #85031 - 100% Polyester Pouch With Drawstring, #6223 Malibu Sunglasses, #287 Rechargeable Handheld Fan With Carabiner And #9089 - 1 Oz. SPF 30 Sunscreen With Carabiner
- Price Includes 1-Color/1-Location Imprint On #85031 - 100% Polyester Pouch With Drawstring, #6223 Malibu Sunglasses & #287 Rechargeable Handheld Fan With Carabiner And 4-Color Process On White Label On #9089 - 1 Oz. SPF 30 Sunscreen With Carabiner



**#95233 BBQ TOOL SET**

- Set Includes BBQ Spatula & Tongs
- Pouch With Hook & Loop Closure For Easy Travel & Storage
- Case Is Made Of 300D Polyester
- Meets FDA Requirements



**#99980 BE ADVENTUROUS HARD CASE SET**

- Set Includes #2509 Aluminum LED Flashlight and #80020 Hard Case With Foam - Small
- Pricing Includes Laser Engraved Imprint on #2509 Aluminum LED Flashlight and 4 color process on label on #80020 Hard Case With Foam - Small



**#99982 BE PREPARED HARD CASE SET**

- Set Includes #2527 Telescopic Aluminum Flashlight With Magnet And #80021 Hard Case With Foam - Large
- Pricing Includes Laser Engraved Imprint on #2527 Telescopic Aluminum Flashlight With Magnet and 4 color process on label on #80021 Hard Case With Foam - Large.



#30148 THE TERRY ESSENTIALS SET

- Set Includes #15039 Terry Bucket Hat and #30138 Terry Tote Bag
- Pricing Includes Embroidery on #15039 Terry Bucket Hat and 1 Color/1 Location Imprint on #30138 Terry Tote Bag

#99925 INTREPID PICKLEBALL KIT

- Set Includes #35096 Pickleball Carryall Backpack, #40002 - 3 PC. Pickleball Set And #50035 - 40 Oz. Intrepid Stainless Steel Tumbler
- Pricing Includes 1 Color/1 Location Imprint On #35096 Pickleball Carryall Backpack, #50035 - 40 Oz. Intrepid Stainless Steel Tumbler and #40002 - 3 PC. Pickleball Set. Paddles And Ball Included In #40002 - 3 PC. Pickleball Set Not Imprinted.



#55280 INTREPID COMMUTER KIT

- Set Includes #30131 Intrepid rPET Tote Bag And #50035 - 40 Oz. Intrepid Stainless Steel Tumbler
- Pricing Includes 1-Color/1-Location Imprint On Each Item

